



TRIPLE OUTPUT POWER SUPPLY

MODELS 6236B AND 6237B

**OPERATING AND SERVICE MANUAL FOR:
MODEL 6236B, SERIALS 1705A-00101 AND ABOVE
MODEL 6237B, SERIALS 1706A-00101 AND ABOVE**

* For instruments with serial numbers above those listed, a change page may be included. Refer to Appendix A for manual back-dating changes applying to Model 6236A and 6237A supplies.

Hewlett-Packard

SAFETY SUMMARY

The following general safety precautions must be observed during all phases of operation, service, and repair of this instrument. Failure to comply with these precautions or with specific warnings elsewhere in this manual violates safety standards of design, manufacture, and intended use of the instrument. Hewlett-Packard Company assumes no liability for the customer's failure to comply with these requirements.

BEFORE APPLYING POWER.

Verify that the product is set to match the available line voltage and the correct fuse is installed.

GROUND THE INSTRUMENT.

This product is a Safety Class 1 instrument (provided with a protective earth terminal). To minimize shock hazard, the instrument chassis and cabinet must be connected to an electrical ground. The instrument must be connected to the ac power supply mains through a three-conductor power cable, with the third wire firmly connected to an electrical ground (safety ground) at the power outlet. For instruments designed to be hard-wired to the ac power lines (supply mains), connect the protective earth terminal to a protective conductor before any other connection is made. Any interruption of the protective (grounding) conductor or disconnection of the protective earth terminal will cause a potential shock hazard that could result in personal injury. If the instrument is to be energized via an external autotransformer for voltage reduction, be certain that the autotransformer common terminal is connected to the neutral (earthed pole) of the ac power lines (supply mains).

INPUT POWER MUST BE SWITCH CONNECTED.

For instruments without a built-in line switch, the input power lines must contain a switch or another adequate means for disconnecting the instrument from the ac power lines (supply mains).

DO NOT OPERATE IN AN EXPLOSIVE ATMOSPHERE.

Do not operate the instrument in the presence of flammable gases or fumes.

KEEP AWAY FROM LIVE CIRCUITS.

Operating personnel must not remove instrument covers. Component replacement and internal adjustments must be made by qualified service personnel. Do not replace components with power cable connected. Under certain conditions, dangerous voltages may exist even with the power cable removed. To avoid injuries, always disconnect power, discharge circuits and remove external voltage sources before touching components.

DO NOT SERVICE OR ADJUST ALONE.

Do not attempt internal service or adjustment unless another person, capable of rendering first aid and resuscitation, is present.

DO NOT EXCEED INPUT RATINGS.

This instrument may be equipped with a line filter to reduce electromagnetic interference and must be connected to a properly grounded receptacle to minimize electric shock hazard. Operation at line voltages or frequencies in excess of those stated on the data plate may cause leakage currents in excess of 5.0 mA peak.

SAFETY SYMBOLS.



Instruction manual symbol: the product will be marked with this symbol when it is necessary for the user to refer to the instruction manual (refer to Table of Contents).



Indicates hazardous voltages.



or



Indicate earth (ground) terminal.

WARNING

The WARNING sign denotes a hazard. It calls attention to a procedure, practice, or the like, which, if not correctly performed or adhered to, could result in personal injury. Do not proceed beyond a WARNING sign until the indicated conditions are fully understood and met.

CAUTION

The CAUTION sign denotes a hazard. It calls attention to an operating procedure, or the like, which, if not correctly performed or adhered to, could result in damage to or destruction of part or all of the product. Do not proceed beyond a CAUTION sign until the indicated conditions are fully understood and met.

DO NOT SUBSTITUTE PARTS OR MODIFY INSTRUMENT.

Because of the danger of introducing additional hazards, do not install substitute parts or perform any unauthorized modification to the instrument. Return the instrument to a Hewlett-Packard Sales and Service Office for service and repair to ensure that safety features are maintained.

Instruments which appear damaged or defective should be made inoperative and secured against unintended operation until they can be repaired by qualified service personnel.

SECTION I GENERAL INFORMATION

1-1 INTRODUCTION

1-2 This manual covers two triple output power supply models, the 6236B and 6237B. Both models are compact general purpose bench supplies that are particularly useful for powering developmental IC circuits, both linear and digital. Unless one model or the other is specifically identified, all information in this manual applies to both the 6236B and the 6237B.

CAUTION

Carefully read Sections II and III of this manual before attempting to operate the power supply.

1-3 DESCRIPTION

1-4 These constant-voltage/current-limiting triple output supplies combine two 0 to $\pm 20\text{V}$ tracking outputs rated at 0.5 amps with an additional single output that in the Model 6236B is rated at 0 to +6 volts and up to 2.5 amps, and in the Model 6237B is rated at 0 to +18 volts and 1 amp. The +20V and -20V tracking outputs can also be used in series as a single 0 to 40V 0.5-amp output. Connections to the supply's output and to chassis ground are made to binding posts on the front panel. The supply's three outputs share a common output terminal, which is isolated from chassis ground so that any one output terminal can be grounded.

1-5 All outputs are protected against overload and short-circuit damage. The +18V output in the 6237B and the $\pm 20\text{V}$ outputs in both models are protected by circuits that limit the output current to 110% of its nominal maximum. The overload protection circuit for the +6V output in the 6236B has a current foldback characteristic that reduces the output current as an overload increases until only 1 amp flows through a short circuit. The 6V output's current limit depends on the output terminal voltage and varies linearly between 2.75 amps at 6 volts and 1 amp at zero volts.

1-6 All controls, meters, and output terminals are

located on the front panel. One voltage control sets the 0 to +6V (or +18V) output and another sets the voltages of the 0 to +20V and 0 to -20V outputs simultaneously. These dual tracking outputs are made more versatile by the provision of a tracking ratio control in addition to the usual voltage control. With the tracking ratio control turned fully clockwise to its "fixed" position, the dual outputs have a fixed 1:1 tracking ratio. As the $\pm 20\text{V}$ voltage control is adjusted, the voltage of the negative supply tracks the positive output within $\pm 1\%$. Turning the tracking ratio control away from its fully-clockwise position switches the dual tracking outputs into a variable tracking ratio mode. In this mode the voltage of the negative output can be set lower than that of the positive output. The tracking ratio control allows the negative supply's output to be set to any value between a maximum that is within 10% of the positive supply's output and a minimum that is less than 0.5 volts. Once a ratio is established by the tracking ratio control, the ratio of the positive output voltage to the negative output voltage remains constant as the $\pm 20\text{V}$ voltage control varies the 0 to +20V output over its range.

1-7 The front panel also contains a line switch and a pilot light, a voltmeter and an ammeter, and a meter switch that selects one of the supply's three outputs to be monitored on both dual-range meters.

1-8 In addition to the standard 104-to-127Vac 47-to-63Hz input, three other line voltage options are available for nominal inputs of 100, 220, and 240 Vac. The supply is furnished with a permanently attached 5-foot 3-wire grounding type line cord. The ac line fuse is in an extractor type fuseholder on the rear heatsink.

1-9 SPECIFICATIONS

1-10 Table 1-1 lists detailed specifications for the power supply.

1-11 OPTIONS

1-12 Options are factory modifications of a standard instrument that are requested by the customer. The following options are available for the instruments covered by this manual.

<u>OPTION NO.</u>	<u>DESCRIPTION</u>
100	Input Power: 87-106Vac, 47-63Hz single-phase.
220	Input Power: 191-233Vac, 47-63Hz, single-phase.
240	Input Power: 208-250Vac, 47-63Hz, single-phase.
910	One additional operating and service manual shipped with the power supply.

1-13 Before the supply is shipped from the factory, an internal line voltage selector switch is set and the proper fuse installed for the line voltage specified on the order. A label on the rear heatsink identifies this line voltage option.

CAUTION

Before applying power to the supply, make certain that its line voltage selector switch (S3) is set for the line voltage to be used. (See CAUTION notice in paragraph 3-2 for additional information.)

The user can convert an instrument from one line voltage option to another by following the instructions in paragraph 3-4.

1-14 ACCESSORIES

1-15 The accessories listed below may be ordered from your local Hewlett-Packard field sales office either with the power supply or separately. (Refer to the list at the rear of the manual for addresses.)

<u>HP PART NO.</u>	<u>DESCRIPTION</u>
14513A	Rack Mounting Kit for mounting one 3 1/2" high supply in a standard 19" relay rack.
14523A	Rack Mounting Kit for mounting two 3 1/2" high supplies side by side in a standard 19" relay rack.

Table 1-1. Specifications, Model 6236B and 6237B

NOTE	
<p align="center"><i>Specifications apply to both models unless otherwise indicated.</i></p> <p>INPUT POWER: Standard: 104-127Vac (120Vac nominal), 47-63Hz, single-phase, 112W, 140VA (Other line voltage options are listed in paragraph 1-12).</p> <p>DC OUTPUT AND OVERLOAD PROTECTION: 0 to $\pm 20V$ Outputs: Maximum rated output current is 0.5A. Short circuit output current is 0.55A $\pm 5\%$ and a fixed current limit circuit limits the output of each supply to this maximum at any output voltage setting. Unbalanced loads within current rating are permitted. (Switching to the variable tracking ratio mode allows the $-20V$ output to be varied from less than $-0.5V$ to within $\pm 10\%$ of the voltage setting of the $+20V$ output.)</p> <p>Model 6236B 0 to $+6V$ Output: Maximum rated output current is 2.5A at 6V. The maximum available output current decreases with the output voltage setting. A current foldback circuit limits the output to 2.75A $\pm 5\%$ at 6 volts and, with decreasing voltage, reduces the current limit linearly to 1A $\pm 15\%$ at zero volts (short circuited).</p>	<p>Model 6237B 0 to $+18V$ Output: Maximum rated output current is 1.0A. Short circuit output current is 1.1A $\pm 5\%$ and a fixed current limit circuit limits the output to this maximum at any output voltage setting.</p> <p>TRACKING ACCURACY: The $+20V$ and $-20V$ outputs track within 1% with the TRACKING RATIO control in the FIXED position.</p> <p>LOAD EFFECT (Load Regulation): All Outputs: Less than 0.01% plus 2mV for a full load to no load change in output current.</p> <p>SOURCE EFFECT (Line Regulation): All Outputs: Less than 0.01% plus 2mV for any line voltage change within rating.</p> <p>PARD (Ripple and Noise): All Outputs: Less than 0.35mV rms and 1.5mV p-p (20 Hz to 20 MHz).</p> <p>DRIFT (Stability): All Outputs: Less than 0.1% plus 5mV (dc to 20Hz) during 8 hours at constant line, load, and ambient after an initial warm-up time of 30 minutes.</p>

1-16 INSTRUMENT AND MANUAL IDENTIFICATION

1-17 Hewlett-Packard power supplies are identified by a two part serial number. The first part is the serial number prefix, a number-letter combination that denotes the date of a significant design change and the country of manufacture. The first two digits indicate the year (10 = 1970, 11 = 1971, etc.) the second two digits indicate the week, and the letter "A" designates the U.S.A. as the country of manufacture. The second part is the power supply serial number. A different sequential number is assigned to each power supply, starting with 00101.

1-18 If the serial number on your instrument does not agree with those on the title page of the manual, Change Sheets supplied with the manual or Manual Backdating Changes define the difference between your instrument and the instrument described by this manual.

1-19 ORDERING ADDITIONAL MANUALS

1-20 One manual is shipped with each power supply unless Option 910 is ordered for each extra manual. Additional manuals may be purchased from your local Hewlett-Packard field office (see the list at the rear of this manual for addresses). Specify the model number, serial number prefix, and the HP Part Number provided on the title page.

Table 1-1. Specifications, Models 6236B and 6237B (Continued)

<p>LOAD EFFECT TRANSIENT RECOVERY TIME: All Outputs: Less than 50μsec for output recovery to within 15mV of nominal output voltage following a load change from full load to half load (or vice versa).</p> <p>OUTPUT VOLTAGE OVERSHOOT: All Outputs: During turn-on or turn-off of ac power, output plus overshoot will not exceed 1V if the output control is set for less than 1V. If the control is set for 1V or higher, there is no overshoot.</p> <p>TEMPERATURE COEFFICIENT: All Outputs: Less than 0.02% plus 1mV voltage change per degree Celsius over the operating range from 0 to 40°C after 30 minutes warm-up.</p> <p>*OUTPUT IMPEDANCE (typical): 0 to +20V Output: 0.5mΩ plus 1.5μH 0 to -20V Output: 0.5mΩ plus 1.5μH</p> <p>Model 6236B 0 to +6V Output: 0.3mΩ plus 1μH</p> <p>Model 6237B 0 to +18V Output: 0.3Ω plus 1.5μH</p> <p>* Operating characteristics listed as typical are provided for the user's information only and are not warranted specifications.</p> <p>METER ACCURACY: ±4% of full scale</p>	<p>RESOLUTION: (Minimum output voltage change obtainable using front panel voltage control) 0 to ±20V Outputs: 70mV Model 6236B 0 to +6V Output: 20mV</p> <p>Model 6237B 0 to +18V Output: 70mV</p> <p>TEMPERATURE RATINGS: Operating: 0 to +40°C ambient. At higher temperatures, output current is derated linearly to 50% at 55°C maximum temperature. Storage: -40°C to +75°C.</p> <p>METER RANGES: 0 to +20V Output: 0-25V, 0-0.6A 0 to -20V Output: 0-25V, 0-0.6A</p> <p>Model 6236B 0 to +6V Output: 0-7V, 0-3A</p> <p>Model 6237B 0 to +18V Output: 0-21V, 0-1.2A</p> <p>DIMENSIONS: 3.47 in. H x 8.22 in. W x 12.56 in. D (88mm H x 209mm W x 319mm D)</p> <p>WEIGHT: 9.5 lb (4.3kg)</p>
---	--

SECTION II INSTALLATION

2-1 INITIAL INSPECTION

2-2 Before shipment, this instrument was inspected and found to be free of mechanical and electrical defects. As soon as the instrument is unpacked, inspect for any damage that may have occurred in transit. Save all packing materials until the inspection is completed. If damage is found, file claim with carrier immediately. The Hewlett-Packard Sales and Service office should be notified as soon as possible.

2-3 Mechanical Check

2-4 This check should confirm that there are no broken knobs or connectors, that the cabinet and panel surfaces are free of dents and scratches, and that the meter is not scratched or cracked.

2-5 Electrical Check

2-6 The instrument should be checked against its electrical specifications. Section V includes an "in-cabinet" performance check to verify proper instrument operation.

2-7 INSTALLATION DATA

2-8 The instrument is shipped ready for bench operation. Before applying power to the instrument, see the CAUTION notice in paragraph 3-2.

2-9 Location

2-10 This instrument is air cooled. Sufficient space should be allotted so that a free flow of cooling air can reach the rear of the instrument when it is in operation. It should be used in an area where the ambient temperature does not exceed 40°C (up to 55°C with derating).

2-11 Outline Diagram

2-12 Figure 2-1 illustrates the outline shape and dimensions of this supply.

2-13 Rack Mounting

2-14 This instrument may be rack mounted in a standard 19-inch rack panel either by itself or alongside a similar unit. Figures 2-2 and 2-3 show the components of the rack mounting kits available for this power supply. Ordering information for rack mounting accessories is given in paragraph 1-14.

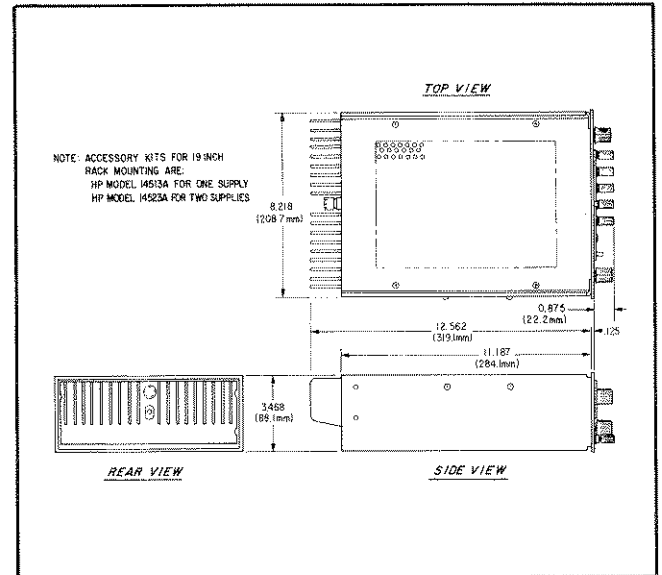

Figure 2-1. Outline Diagram

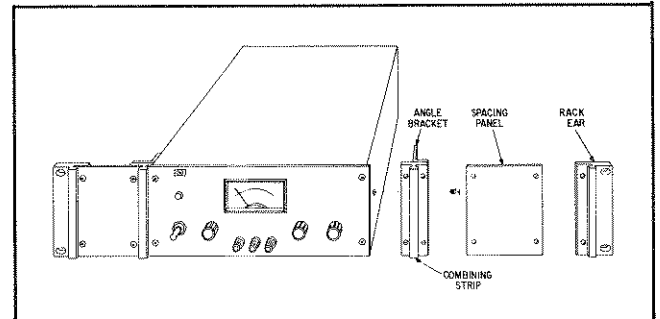

Figure 2-2. Rack Mounting, One Unit

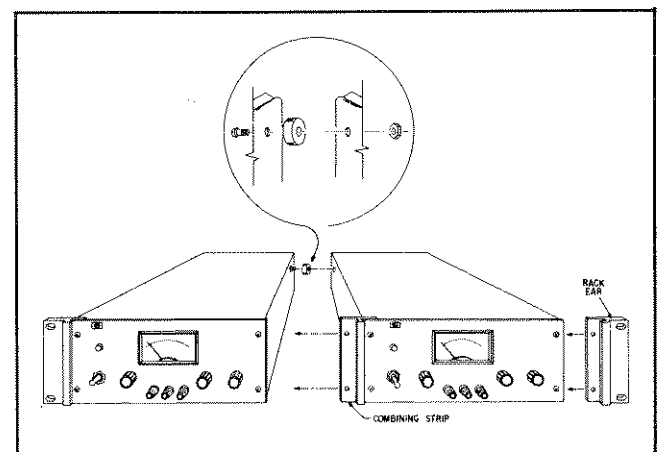

Figure 2-3. Rack Mounting, Two Units

2-15 Input Power Requirements

2-16 Depending on the line voltage option ordered, the supply is ready to be operated from one of the power sources listed in Table 2-1. The input voltage range, and the input current and power at high line voltage and full load is listed for each option. A label on the rear heat sink identifies the line voltage option of your supply. All options of this model operate from a 47-63 Hz single-phase line.

2-17 If desired, the user can easily convert the unit from any of these options to another by following the instructions in paragraph 3-4. A unit is converted by resetting an internal line voltage selector switch, replacing the fuse, and changing the line voltage tag.

CAUTION

If the supply might possibly have been converted to a line voltage option other than the one marked on its identifying label without being relabeled in some way, check the setting of the line voltage selector switch and the fuse rating before applying power. (See CAUTION in paragraph 3-2.)

2-18 Power Cable

2-19 To protect operating personnel, the National Electrical Manufacturers Association (NEMA) recommends that the instrument panel and cabinet be grounded. This instrument is equipped with a three conductor power cable. The third conductor is the ground conductor and when the cable is plugged into an appropriate receptacle, the instrument is grounded. The offset pin on the power cable three-prong connector is the ground connection. In no event shall this instrument be operated without an adequate cabinet ground connection.

2-20 To preserve the protection feature when operating the instrument from a two-contact outlet, use a three-prong to two-prong adapter (if permitted by local regulations) and connect the green lead on the adapter to ground.

2-21 Model 6236B and 6237B supplies are equipped at the factory with a power cord plug appropriate for the user's location. Figure 2-4 illustrates the standard configurations of power cord plugs used by HP. Above each drawing is the HP option number for that configuration of power connector pins. Below each drawing is the HP Part Number for a replacement power cord equipped with a plug of that configuration. Notify the nearest HP Sales and Service Office if the appropriate power cord is not included with the instrument.

2-22 Repackaging for Shipment

2-23 To insure safe shipment of the instrument, it is recommended that the package designed for the instrument be used. The original packaging material is reusable. If it is not available, contact your local Hewlett-Packard field office to obtain the materials. This office will also furnish the address of the nearest service office to which the instrument can be shipped and provide the Authorized Return label necessary to expedite the handling of your instrument return. Be sure to attach a tag to the instrument which specifies the owner, model number, full serial number, and service required, or a brief description of the trouble.

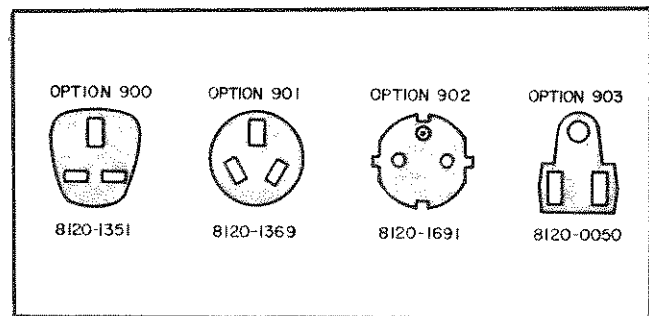

Figure 2-4. Power Cord Configurations

Table 2-1. Input Power Requirements

Option	Line Voltage Range	Input Current	Input Power
100 (100 Vac)	87-106 Vac	1.3A	140 VA
Standard (120 Vac)	104-127 Vac	1.1A	140 VA
220 (220 Vac)	191-233 Vac	0.6A	140 VA
240 (240 Vac)	208-250 Vac	0.55A	140 VA

SECTION III OPERATING INSTRUCTIONS

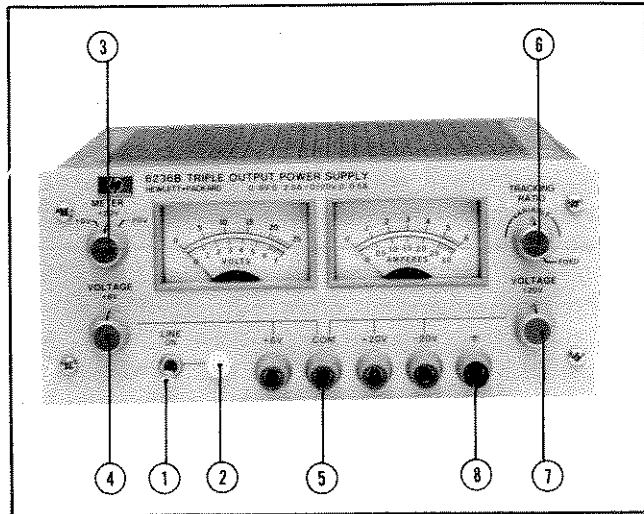

Figure 3-1. Controls and Indicators

3-1 TURN-ON CHECKOUT PROCEDURE

3-2 The following steps describe the use of the Model 6236B or 6237B front panel controls and indicators illustrated in Figure 3-1 and serve as a brief check that the supply is operational. Follow this checkout procedure or the more detailed performance test of paragraph 5-6 when the instrument is received and before it is connected to any load equipment. Proceed to the more detailed procedures beginning in paragraph 5-6 if any difficulties are encountered.

CAUTION

Before applying power to the supply, make certain that its line voltage selector switch (S3) is set for the line voltage to be used. This switch is mounted on the circuit board behind the voltmeter and is visible through the perforations in the top cover. The positions of the two white marks on the switch indicate the switch setting (see Figure 3-2). If the switch setting does not correspond to the intended power source, proceed to paragraph 3-4 before applying power.

NOTE

For the Model 6237B, substitute +18V for +6V in the following steps.

- a. Connect line cord to power source and turn LINE switch ① on. LINE ON indicator ② will light.
- b. Set METER switch ③ to the +6V position and, with no load connected, vary +6V VOLTAGE control ④ over its range and check that the voltmeter responds to the control setting and the ammeter indicates zero.
- c. Set the +6V VOLTAGE control for a 6-volt meter indication and short the +6V output terminal to COM (common) terminal ⑤ with an insulated test lead. The ammeter should indicate a short-circuit output current of approximately 1.0A (1.1A in the 6237B). Remove the short from the output terminals.
- d. Set the METER switch to the +20V position and turn TRACKING RATIO control ⑥ fully clockwise to the FIXED position. With no load connected, vary ±20V VOLTAGE control ⑦ over its range and check that the voltmeter responds to the control setting and the ammeter indicates zero.
- e. Set the ±20V VOLTAGE control for a 20-volt meter indication and short the +20V output terminal to the common terminal with an insulated test lead. The ammeter should indicate a short-circuit output current of 0.55A ±5%. Remove the short from the output terminals.
- f. Repeat steps (d) and (e), but substitute the -20V position of the METER switch and the -20V output terminal.
- g. Adjust the +20V output for a 20V meter indication. Then set the METER switch to the -20V position and check the effect of the TRACKING RATIO control on the voltage of the -20V output. The -20V output should be adjustable from less than 0.5 volts to a maximum of 18 to 22 volts.

3-3 If this brief checkout procedure or later use of the supply reveals a possible malfunction, see Section V of this manual for detailed test, troubleshooting, and adjustment procedures.

3-4 LINE VOLTAGE OPTION CONVERSION

3-5 To convert the supply from one line voltage option to another, the following three steps are necessary:

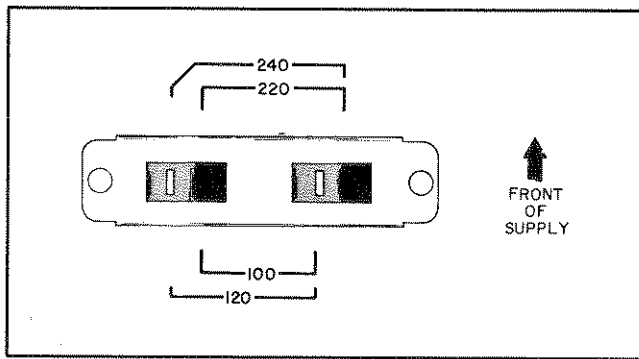

Figure 3-2. Line Voltage Selector (Set for 120 Vac)

1. After making certain that the line cord is disconnected from a source of power, remove the top cover from the supply and set the two sections of the line voltage selector switch for the desired line voltage (see Figure 3-2).

2. Check the rating of the installed fuse and replace it with the correct value, if necessary. For Options 100 or 120, use a normal time-constant 2-amp fuse (HP Part No. 2110-0002). For Options 220 or 240, use a normal time-constant 1-amp fuse (HP Part No. 2110-0001).

3. Mark the instrument clearly with a tag or label indicating the correct line voltage to be used.

3-6 OPERATION

3-7 This power supply can be operated individually or in parallel with another supply (see paragraph 3-19). All output terminals are isolated from ground. The $\pm 20\text{V}$ and $+6\text{V}$ or $+18\text{V}$ outputs use a single common output terminal. This common (COM) terminal or any one of the other output terminals may be grounded to the chassis at the front panel ground terminal (8 in Figure 3-1), or all outputs may be left floating. Loads can be connected separately between each of the 0 to 20V output terminals and the COM terminal, or between the -20V and the $+20\text{V}$ terminals for a 0 to 40V output.

3-8 Tracking Ratio Control

3-9 With the TRACKING RATIO control in the FIXED position, the voltage of the -20V supply tracks that of the $+20\text{V}$ supply within 1% for convenience in varying the symmetrical voltages needed by operational amplifiers and other circuits using balanced positive and negative inputs. Turn the TRACKING RATIO control counterclockwise out of the FIXED position to set the voltage of the -20V supply lower than that of the $+20\text{V}$ supply. The negative supply can be set from a minimum of less than 0.5 volts to a maximum within 10% of the $+20\text{V}$ supply's output. Once this is done, the $\pm 20\text{V}$ VOLTAGE control still controls both outputs and maintains a constant ratio between their voltages.

3-10 Overload Protection Circuits

3-11 $\pm 20\text{-Volt Current Limit}$. The $+20\text{V}$ and -20V outputs are individually protected against overload or short-circuit damage by separate current limit circuits adjusted at the factory to limit the output current to $0.55\text{A} \pm 5\%$. (This is 110% of the maximum rated output.) The current limits can be set by adjusting resistor R6 for the $+20\text{V}$ output and R26 for the -20V output. (See paragraph 5-47 for current limit calibration instructions.) No deterioration of supply performance occurs if the output current remains below the current limit setting. If a single load is connected between the $+20\text{V}$ and -20V outputs, the circuit set for the lesser current limit will limit the output.

3-12 $+6\text{V Current Foldback (Model 6236B)}$. The overload and short-circuit protection circuit for the $+6\text{V}$ output of the Model 6236B reduces the output current limit as the output terminal voltage decreases. (The operating region of the $+6\text{V}$ output is enclosed by heavy lines in Figure 3-3). The maximum rated output current is 2.5A and the current limit is factory-adjusted to operate at $2.75\text{A} \pm 5\%$ when the output is 6 volts. At lower output voltages, the circuit reduces the maximum obtainable output current linearly until $1\text{A} \pm 15\%$ flows when the output is shorted. The short-circuit current cannot be adjusted, but R46 can be set to limit the maximum current at 6V to $2.75\text{A} \pm 5\%$. (See paragraph 5-47 for current limit calibration instruction.)

3-13 $+18\text{Volt Current Limit (Model 6237B)}$. The $+18\text{-volt}$ output of the Model 6237B is protected by a fixed current limit circuit that operates at 1.1A (110% of its maximum rated output). The circuit is similar to the ones in the $\pm 20\text{-volt}$ supplies. (See paragraph 5-47 for calibration instructions.)

3-14 Operation Beyond Rated Output

3-15 The supply may be able to provide voltages and currents greater than its rated maximum outputs if the line voltage is at or above its nominal value. Operation can extend into the shaded areas on the meter faces without damage to the supply, but performance cannot be guaranteed to meet specifications. If the line voltage is maintained in the upper end of the input voltage range, however, the supply probably will operate within its specifications.

3-16 Connecting Loads

3-17 Connect each load to the power supply output terminals using separate pairs of connecting wires. This minimizes mutual coupling between loads and takes full advantage of the low output impedance of the supply. Load wires must be of adequately heavy gauge to maintain satisfactory regulation at the load. Make each pair of connecting wires as short as possible and twist or shield

them to reduce noise pick-up. If shielded wire is used, connect one end of the shield to the power supply ground terminal and leave the other end unconnected.

3-18 If load considerations require locating output power distribution terminals at a distance from the power supply, then the power supply output terminals should be connected to the remote distribution terminals by a pair of twisted or shielded wires and each load should be connected to the remote distribution terminals separately.

3-19 Parallel Operation

3-20 Two or more power supplies can be connected in parallel to obtain a total output current greater than that available from one supply. The total output current is the sum of the output currents of the individual supplies. The output voltage controls of one power supply should be set to the desired output voltage, and the other supply set for a slightly larger output voltage. The supply set to the lower output voltage will act as a constant voltage source, while the supply set to the higher output will act as a current-limited source, dropping its output voltage until it equals that of the other supply. The constant voltage source will deliver only that fraction of its rated output current necessary to fulfill the total current demand.

3-21 Special Operating Considerations

3-22 Pulse Loading. The power supply will automatically cross over from constant-voltage to current-limit operation in response to an increase in the output current over the preset limit. Although the preset limit may be set higher than the average output current, high peak currents as occur in pulse loading may exceed the preset current limit and cause crossover to occur and degrade performance.

3-23 Output Capacitance. An internal capacitor across the output terminals of the power supply helps to supply high-current pulses of short duration during constant-voltage operation. Any capacitance added externally will improve the pulse current capability, but will decrease the load protection provided by the current limiting circuit. A high-current output pulse may damage load components before the average output current is large enough to cause the current limiting circuit to operate.

3-24 Reverse Current Loading. An active load connected to the power supply may actually deliver a reverse current to the supply during a portion of its operating cycle. An external source cannot be allowed to pump current into the supply without risking loss of regulation and possible damage to the output capacitor. To avoid these effects, it is necessary to preload the supply with a dummy load resistor so that the power supply delivers current through the entire operating cycle of the load device.

3-25 Reverse Voltage Protection. Internal diodes connected with reverse polarity across the output terminals protect the output electrolytic capacitors and the driver transistors from the effects of a reverse voltage applied across a supply output. Since series regulator transistors cannot withstand reverse voltage either, diodes are also connected across them. When operating supplies in parallel, these diodes protect an unenergized supply that is in parallel with an energized supply.

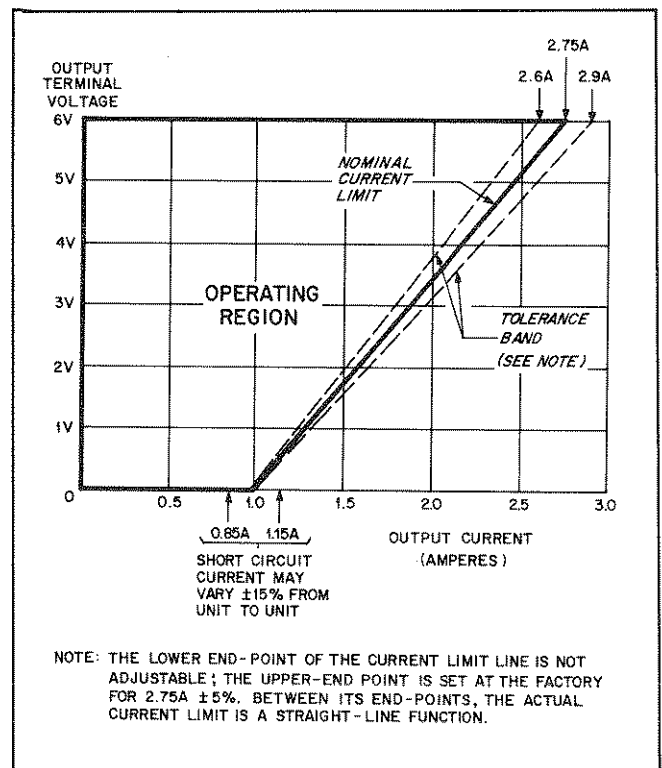

Figure 3-3. Current Limit Characteristics of the 6V Supply (Model 6236B)

SECTION IV PRINCIPLES OF OPERATION

4-1 OVERALL DESCRIPTION

4-2 This section presents the principles of operation of the Models 6236B and 6237B Triple Output Power Supply. Throughout this section refer to the combined schematic diagram of Figure 7-1.

NOTE

All information in this section applies to both models unless otherwise indicated.

4-3 The two primary windings of the power transformer are connected in one of four different ways by setting the two slide switches mounted on the circuit board. These switches select one of the nominal ac input voltages for which the supply is designed: 100V, 120V, 220V, or 240V.

4-4 The transformer secondaries, together with rectifiers and capacitor filters, provide raw dc for the three output regulator circuits and for another regulator that provides reference and bias voltages to the output regulators.

4-5 By comparing its output to a high-stability reference, the 0 to +6-volt regulator (6236B) or 0 to +18-volt regulator (6237B) holds its output voltage at the value determined by a front panel control. Any error in the actual output as compared to the desired output is amplified by an operational amplifier and applied as feedback to control the conduction of a series regulator transistor. As a result, the voltage across the series transistor varies so as to hold the output voltage constant at the desired level. The high gain of the voltage comparison amplifier and the stability of the reference voltage ensure that input voltage or load current variations have little effect on the output voltage.

4-6 The 0 to +6-volt output in the Model 6236B is protected by a current foldback limiter to minimize dissipation in the series regulator transistor during overloads. In a current foldback circuit, the current limit depends on the output terminal voltage and in this regulator ranges from 2.75A \pm 5% at 6 volts to 1A \pm 15% with the output shorted. (An output of 2.75A is 110% of the 2.5A rated maximum at 6 volts.) The operating region of the +6-volt regulator output is enclosed by a heavy line in Figure 3-3. If the operating point reaches the diagonal current limit line, a decrease in load resistance moves the operating point

down the line, reducing the output voltage and current. Current foldback is controlled by a second operational amplifier in the regulator that monitors the dc output current. This current comparison amplifier takes control of the output away from the voltage comparison amplifier when the current reaches the design limit. Removing the overload restores constant voltage operation automatically.

4-7 The +20-volt regulator has a fixed current limit at 110% of its 0.5 amp maximum rated output but is otherwise similar to the +6-volt regulator.

4-8 The 0 to -20-volt regulator is, in turn, similar to the +20-volt regulator except that it resembles a complementary mirror image of the latter. The output voltages of the +20-volt and -20-volt supplies are both set by the same front panel control and track each other within 1% in the fixed tracking ratio mode. Precise tracking of the two outputs is achieved by controlling the positive output conventionally and using that output as the reference voltage for the negative output.

4-9 The 0 to +18-volt regulator in the Model 6237B is similar to the +20-volt regulator. It has a fixed current limit at 110% of its 1.0 amp output.

4-10 The reference and bias supply provides reference and bias voltages for the output regulators.

4-11 The turn-on/turn-off control circuit prevents output transients when the supply is turned on or off. It does this by delaying the application of certain bias and reference voltages at turn-on and removing them shortly after turn-off.

4-12 A three-position meter switch selects which of the supplies has its output voltage and current indicated on the front panel meters. The proper range of the dual-range meters is selected automatically.

4-13 DETAILED CIRCUIT DESCRIPTION

4-14 0 To +20-Volt Regulator

4-15 **Voltage Comparison Amplifier.** The voltage comparison amplifier in the +20-volt supply controls the conduction of series regulator transistor Q1 so that the voltages at the two inputs of the amplifier remain equal. A fixed voltage divider holds its inverting input (U1-2) at -16mV. Its non-inverting input (U1-3) monitors the output voltage in

series with the voltage across R1. Since R2 is connected between the -6.2V reference supply and a point that feedback action holds near -16mV , its current remains constant. This current flows through R1 to produce a voltage drop across R1 proportional to its resistance setting, thus the output voltage of the supply is proportional to the resistance setting of R1. At the output of the voltage comparison amplifier (U1-1), a positive voltage change corresponds to a decrease in the conduction of Q1.

4-16 CR2 and CR3 protect the input of the amplifier against transient overloads, C2 and R4 speed up loop response time, and C4 and R12 stabilize the supply's high frequency characteristics.

4-17 OR-Gate. To permit either the voltage comparison amplifier or the current comparison amplifier to control the series regulator transistor, the outputs of both amplifiers are connected to the base of driver Q2 through an OR-gate composed of CR5 and CR6. CR5 is normally reverse biased by a negative output from the current comparison amplifier, permitting the voltage comparison amplifier to drive Q2 through CR6. An overload drives the output of the current comparison amplifier positive, forward biasing CR5 and reducing the supply output. When the overload is removed, CR5 is reverse biased again and the voltage comparison amplifier resumes control of the output.

4-18 Driver and Series Regulator. The -12.4V output of the bias supply provides the turn-on bias for series regulator transistor Q1. Its complete current path includes Q15, CR59, R14, and Q1, and returns to common through current monitoring resistor R8. (It is because this bias current flows through R8 that the output ammeter requires the zero offset bias circuit described in paragraph 4-43.) Through the OR-gate, either the voltage or the current comparison amplifier controls the conduction of driver Q2, which regulates the flow of turn-off bias through Q1's base-emitter circuit. The algebraic sum of the nearly constant turn-on bias through R14 and the variable turn-off bias through Q2 controls the conduction of series regulator transistor Q1.

4-19 Current Limit Circuit. In the $+20\text{-volt}$ regulator, the current comparison amplifier compares the voltage across current monitoring resistor R8 to the fixed voltage across part of current limit adjust potentiometer R6. The current limit adjustment is set so that the input voltage to the current comparison amplifier is negative in the normal operating region, but becomes zero when the output current increases to 0.55 amps. When the amplifier's input voltage reaches zero, it takes control of the regulator output voltage and reduces it as necessary to keep the output current from exceeding 0.55 amps. When the overload is removed, the output of the current comparison amplifier goes negative, reverse biasing CR5 and returning control to the voltage

comparison amplifier.

4-20 Turn-On/Turn-Off Control. When the power supply is turned on or off, Q15 in the turn-on control circuit withholds turn-on bias from Q1 while the regulator bias voltages are too low. This prevents an output voltage transient from occurring before the amplifiers are properly biased. The output of the -6.2V reference supply is also temporarily held at a low voltage by Q14, which conducts to short that output.

4-21 Circuit Protection Components. Diodes CR1, CR7, and CR9 each protect the $+20\text{-volt}$ supply from specific hazards. Output diode CR1 protects the supply components if a reverse voltage is applied to the output terminals. A common way for this to occur is for an unenergized supply to be connected in series with another that is energized. If the output voltage is turned down quickly while a large capacitor is connected across the output, CR7 protects driver Q2 from excessive dissipation by shunting some of its base current to common. The series regulator diode, CR9, protects the series regulator transistor from reverse voltage. Reverse series regulator voltage could occur if a deenergized supply were connected in parallel with an energized one.

4-22 0 To -20-Volt Regulator

4-23 Instead of using an NPN driver and a PNP series regulator in the negative output line as in the $+20\text{-volt}$ regulator, the -20-volt regulator uses a PNP driver and an NPN series regulator in the positive output line. The -20-volt regulator circuit is the complementary equivalent of the $+20\text{-volt}$ circuit in other respects, as well. Their current limit circuits operate similarly. At the outputs of the current and voltage comparison amplifiers in the -20-volt circuit, a negative voltage change corresponds to a decrease in series regulator conduction. The turn-on bias for its series regulator transistor, Q3, is supplied from a positive voltage source, the $+7.5\text{V}$ bias supply, and is switched on and off by Q13 in the turn-on control circuit.

4-24 The -20-volt supply uses the output of the $+20\text{-volt}$ supply as its reference voltage. As a result, both outputs are set by a single front panel control and track each other within 1% in the fixed tracking ratio mode. Two resistors in resistor network Z1 are connected in series between the $+20\text{-volt}$ and -20-volt outputs. These resistors are closely matched in resistance and temperature coefficient so that the voltage across each is exactly half of the total. The midpoint of this divider is connected to the non-inverting input of the -20-volt supply's voltage comparison amplifier. The amplifier's inverting input is connected to common through R32 to hold it at zero volts. The amplifier keeps its differential input voltage at zero by matching the output voltage of the -20-volt supply to that of the $+20\text{-volt}$ supply.

4-25 In the variable tracking ratio mode, the tracking ratio control connects a fixed resistor in parallel with the upper part and a rheostat (the variable tracking ratio control) in parallel with the lower part of the voltage divider that forms the -20 -volt reference. Turning the control counterclockwise reduces the resistance of the rheostat and lowers the voltage of the negative output.

4-26 0 To +6-Volt Regulator (Model 6236B)

4-27 Except for differing component designations and values, paragraphs 4-15 through 4-18, 4-20, and 4-21, which describe the voltage comparison amplifier, OR-gate, driver, series regulator, turn-on control, and circuit protection components of the $+20$ -volt regulator circuit, also apply to the $+6$ -volt regulator. The only difference in circuit operation lies in the control of the current comparison amplifier, and thus the type of current limit the supply has.

4-28 **Current Foldback Circuit.** For this discussion refer to the Figure 7-1 schematic and to Figure 4-1.) The differential input signal to the current comparison amplifier is the algebraic sum of three circuit voltages:

1. The voltage across R49. E_{R49} remains constant at -305mV .
2. The voltage across the lower part of R46 (see Figure 4-1). E_{R46} is proportional to the regulator output voltage and equals 440mV when the supply output is 6 volts.
3. The voltage across current monitoring resistor R48. E_{R48} is proportional to the sum of the regulator output current and the 0.22A bias current that flows through R54 and R48.

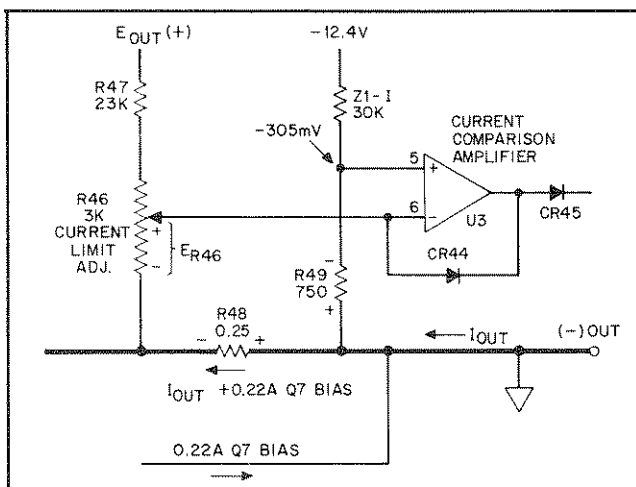

Figure 4-1. Foldback Current Limit Circuit in 6V Supply

4-29 When the supply's output current is below the current limit that corresponds to its output terminal voltage (see Figure 3-3), the inverting input (U3-6) of the current comparison amplifier is more positive than its non-inverting

input (U3-5), which is held at -305mV . The negative amplifier output that results is clamped by CR44 and reverse biases OR-gate diode CR45, leaving the voltage comparison amplifier in control of the supply's output. If the load resistance is decreased, the higher output current increases E_{R48} until the algebraic sum of E_{R48} and E_{R46} makes the current comparison amplifier's inverting input slightly more negative than the -305mV potential on its non-inverting input. When this happens, the output of this amplifier goes positive and forward biases CR45. Since the current through CR45 tends to reduce the output of the supply, the output of the voltage comparison amplifier goes negative in opposition to this change and reverse biases CR46 to leave the current comparison amplifier in control of the output. Now that the current comparison amplifier is in control and for as long as the overload remains, the supply's output voltage and current vary so as to maintain this amplifier's differential input signal near zero volts. This results in the output current limit characteristics shown in Figure 3-3.

4-30 If we assume for example that the voltage control is set for 5 volts and the load resistance is slowly decreased, the supply goes into current limit at about 2.47 amps. Here is why it occurs at that value. At a 5-volt supply output, E_{R46} is $5/6$ of 440mV , or 367mV . In order for the algebraic sum of E_{R46} and E_{R48} to go as far negative as -305mV and drive the amplifier output positive, E_{R48} must reach -672mV . Once E_{R48} reaches this value, the current comparison amplifier controls the series regulator transistor so as to prevent E_{R48} (and thus the supply's output current) from increasing further. At 0.25 ohms, R48 develops -672mV at 2.69 amps. Since 0.22 amps of the current through R48 is bias current for Q7, the nominal current limit corresponding to a 5-volt output is 2.69 amps minus 0.22 amps, or about 2.47 amps.

4-31 If the load resistance continues to decrease, it pulls the output voltage lower. This reduces E_{R46} until at a zero output voltage E_{R46} becomes zero, leaving E_{R48} equal in magnitude to E_{R49} . This -305mV drop across R48 corresponds to a 1.22 -amp current through R48 and a 1 -amp short-circuit current at the output of the supply.

4-32 In the $+6$ -volt regulator, as in the $+20$ -volt regulator, the turn-on bias current for the series regulator transistor is switched on and off by Q15 in the turn-on control circuit to prevent output voltage transients.

4-33 0 To +18-Volt Regulator (Model 6237B)

4-34 Except for differing component designations and

values, paragraphs 4-15 through 4-21, which describe the voltage comparison amplifier, OR-gate, driver, series regulator, current limit circuit, turn-on control, and circuit protection components of the +20-volt regulator circuit, also apply to the +18-volt regulator. In the +18-volt regulator, as in the +20-volt regulator, the turn-on bias current for the series regulator transistor is switched on and off by Q15 in the turn-on control circuit to prevent output voltage transients.

4-35 Reference and Bias Supply

4-36 The reference and bias supply powers the operational amplifiers and provides the bias and reference voltages used throughout the supply. A shunt zener regulates its +7.5V output. A series transistor regulates its -12.4V output, using 6.2-volt zener VR1 as its voltage reference. The -12.4V output provides a constant current to VR1, which is the primary voltage reference for the entire supply.

4-37 Two equal resistors are connected in series across the -12.4V output. To regulate this output, voltage comparison amplifier U4 compares the voltage across one of these resistors to the -6.2V reference and controls the conduction of series regulator Q11 through driver Q12. The voltage drop across Q11 is controlled by feedback so that the voltages at the two inputs of U4 remain equal. Driver Q12 controls Q11 by shunting part of the base bias supplied by R68.

4-38 During turn-on, the -6.2V reference supply is temporarily shorted by Q14 in the turn-on control circuit. By trying to match this low reference, Q11 is initially turned off. While Q11 is turned off, R69 bypasses current to the -12.4V output until the output reaches -9 volts and the turn-on control circuit removes the short from the reference and enables the -12.4-volt regulator to operate normally.

4-39 Turn-On/Turn-Off Control Circuit

4-40 Immediately after the supply is energized and until the output of the -12.4-volt regulator reaches about -9 volts, the turn-on control circuit withholds turn-on bias from series regulator transistors Q1, Q3, and Q7 and holds the -6.2V reference at a low value. This prevents an output voltage transient by ensuring that the operational amplifiers are energized and other essential bias voltages are present before the series regulator transistors are turned on. The circuit also prevents an output transient when the supply is turned off by removing the turn-on bias from the series regulators and shorting the -6.2V reference supply as the voltage of the -12.4V supply falls below -9 volts.

4-41 Q13 switches the bias to the -20-volt regulator on and off, Q14 switches the short across the -6.2-volt reference supply, and Q15 switches the bias to the +20-volt and +6-volt or +18-volt regulators. Q15 remains turned off until VR2 conducts at 9 volts to switch it on. While Q15 is off, it holds Q13 biased off and Q14 on; when Q15 conducts, it turns Q13 and Q14 off.

4-42 Meter Circuits

4-43 **Voltmeter.** Two of the resistors in resistor network Z1 are range resistors for the voltmeter. The accurate ratio of these resistors permits a single calibration potentiometer, R58 to adjust both ranges simultaneously.

4-44 **Ammeter.** The range switch connects the ammeter across the current monitoring resistor of a supply: R48 in the +6-volt or +18-volt supply, R8 in the +20-volt supply, or R28 in the -20-volt supply. Each of these resistors conducts a constant bias current for its series regulator transistor in addition to the supply's output current. If no compensation were used, this additional current would raise the indicated output by up to 8% of full scale. The resistor networks connected to each range of the ammeter selector switch apply a bias to the meter to offset this error. R59 calibrates all ammeter ranges.

SECTION V MAINTENANCE

5-1 INTRODUCTION

5-2 Upon receipt of the power supply, the performance test of paragraph 5-6 can be made. This test is suitable for incoming inspection. Section III contains a quick but less comprehensive checkout procedure that can be used in lieu of the performance test if desired.

5-3 If a fault is detected in the power supply while making the performance test or during normal operation, proceed to the troubleshooting procedure in paragraph 5-32. After troubleshooting and repair, repeat the performance test to ensure that the fault has been properly corrected and that no other faults exist. Before performing any maintenance checks, turn on the power supply and allow a half-hour warm-up.

5-4 TEST EQUIPMENT REQUIRED

5-5 Table 5-1 lists the test equipment required to perform the various procedures described in this section.

5-6 PERFORMANCE TEST

5-7 The following test can be used as an incoming inspection check and appropriate portions of the test can be repeated to check the operation of the instrument after repairs. If the correct result is not obtained for a particular check, proceed to the troubleshooting procedures of paragraph 5-32.

— CAUTION —

Before applying power to the supply, make certain that its line voltage selector switch (S3) is set for the line voltage to be used. (See CAUTION notice in paragraph 3-2 for additional information on S3.)

Table 5-1. Test Equipment Required

TYPE	REQUIRED CHARACTERISTICS	USE	RECOMMENDED MODEL
Digital Voltmeter	Sensitivity: 100mV full scale (min.). Input impedance: 10 megohms (min.).	Measure dc voltages: calibration procedures	HP 3490A
Variable Voltage Transformer	Range: 90–130 Vac Equipped with voltmeter accurate within 1 volt	Vary ac input	-----
Oscilloscope	Sensitivity: 100 μ V/cm. Differential input.	Display transient response and ripple and noise waveforms.	HP 180C with 1821A, and 1801A or 1803A plug-ins.
Repetitive Load Sw.	Rate: 60 Hz, 2 μ s rise and fall time	Measure transient response.	See Figure 5-5.
Resistive Loads	Value: See paragraph 5-11. Tolerance: \pm 5%	Power supply load resistor (fixed resistor or rheostat).	James G. Biddle ("Lubri-Tact" Rheostat)
Current Sampling Resistor (Shunt)	Value: See paragraph 5-13. Accuracy: 1% (minimum)	Measure output current	Simpson Portable Shunt, 06703.

5-8 General Measurement Techniques

5-9 Connecting Measuring Devices. To achieve valid results when measuring the load effect, PARD (ripple and noise), and transient recovery time of the supply, measuring devices must be connected as close to the output terminals as possible. A measurement made across the load includes the impedance of the leads to the load. The impedance of the load leads can easily be several orders of magnitude greater than the supply impedance and thus invalidate the measurement. To avoid mutual coupling effects, each measuring device must be connected directly to the output terminals by separate pairs of leads.

5-10 When measurements are made at the front panel terminals, the monitoring leads must be connected at point A, as shown in Figure 5-1, and not at point B. Connecting the measuring device at point B would result in a measurement that includes the resistance of the leads between the output terminals and the point of connection.

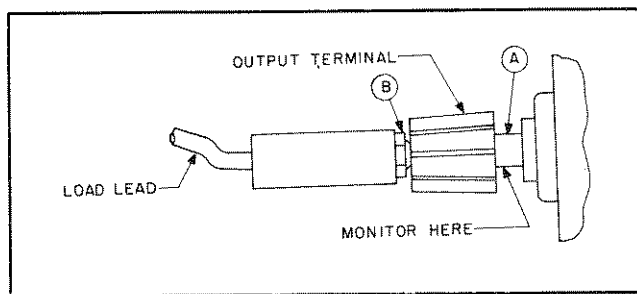

Figure 5-1. Front Panel Terminal Connections

5-11 Selecting Load Resistors. Power supply specifications are checked with a full load resistance connected across the supply output. The resistance and wattage of the load resistor, therefore, must permit operation of the supply at its rated output voltage and current. For example, a supply rated at 20 volts and 0.5 amperes would require a load resistance of 40 ohms at the rated output voltage. The wattage rating of this resistor would have to be at least 10 watts.

5-12 Either a fixed or variable resistor (rheostat) can be used as the load resistance. Using a rheostat (alone or in series with a fixed resistor) is often more convenient than using fixed resistors as loads because the latter may be more difficult to obtain in the exact resistance required. A supplier of rheostats appropriate for testing these supplies is listed in Table 5-1.

5-13 Output Current Measurements. For accurate output current measurements, a current sampling resistor should be inserted between the load resistor and the output of the supply. An accurate voltmeter is then placed across the sampling resistor and the output current calculated by

dividing the voltage across the sampling resistor by its ohmic value. The total resistance of the series combination should be equal to the full load resistance as determined in the preceding paragraphs. Of course, if the value of the sampling resistor is very low when compared to the full load resistance, the value of the sampling resistor may be ignored. The meter shunt recommended in Table 5-1, for example, has a resistance of only 1 milliohm and can be neglected when calculating the load resistance of the supply.

5-14 Figure 5-2 shows a four terminal meter shunt. The load current through a shunt must be fed to the extremes of the wire leading to the resistor while the sampling connections are made as close as possible to the resistance portion itself.

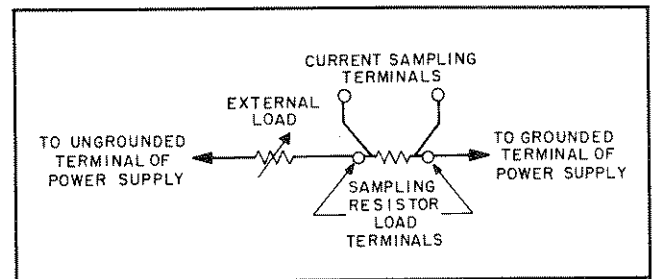

Figure 5-2. Current Sampling Resistor Connections

NOTE

All instructions in this section apply to Models 6236B and 6237B unless otherwise indicated.

5-15 Rated Output, Tracking, Meter Accuracy, and Current Limit

5-16 To check that all supplies will furnish their maximum rated output voltage and current, that the $\pm 20V$ outputs track each other, that the front panel meters are accurate, and that the current limit circuits function, proceed as follows:

Voltmeter Accuracy

- With no loads connected: energize the supply, connect a digital voltmeter between the +6V terminal (+18V in Model 6237B) and common (COM), and set the +6V (+18V) VOLTAGE control so that the DVM indication is as near as possible to 6 volts (18 volts).
- Set the METER switch to the +6V (+18V) range and check the front panel voltmeter indication. It should be within 4% of the DVM indication.
- Set the TRACKING RATIO control to the FIXED position, and check the +20V and -20V ranges of the panel voltmeter similarly by connecting the DVM to each of these outputs in turn, setting the $\pm 20V$ VOLTAGE control for a

20V DVM indication, and verifying that the panel meter is accurate within 4%.

Tracking

d. Connect the DVM to the +20V output, set the $\pm 20\text{V}$ VOLTAGE control for a DVM indication of 20 volts, and reconnect the DVM to the -20V output without disturbing the voltage control. The voltage at the -20V output should be within 1% of the +20V output.

Variable Tracking Ratio

e. Leave the $\pm 20\text{V}$ VOLTAGE control set as in step (d), and use a DVM to monitor the voltage of the -20V supply while adjusting the TRACKING RATIO control over its VARIABLE range. The -20V supply should be capable of being adjusted from less than 0.5 volts to between 18 and 22 volts. Return the TRACKING RATIO control to the FIXED position.

NOTE

Leave the TRACKING RATIO control in the FIXED position throughout the remainder of the performance test.

Rated Output and Ammeter Accuracy

f. Connect 40Ω 10W load resistors across both of the 20V outputs of the supply and set the $\pm 20\text{V}$ VOLTAGE control for a $\pm 20\text{V}$ output. (All three supplies must be fully loaded while checking the rated output voltage and current of each supply.)

g. Connect the test setup shown in Figure 5-3 to the +6V (or +18V) output. Make the total resistance of R_L and the current sampling resistor 2.4 ohms for the Model 6236B (or 18 ohms for the 6237B) to permit operating the output at full load. R_L should have a power rating of at least 20 watts.

h. Close the switch and set the +6V (+18V) VOLTAGE control so that the DVM indicates a voltage drop across the current sampling resistor that corresponds to a current of 2.5 amps (6236B) or 1.0 amp (6237B).

i. Set the METER switch to the +6V (+18V) range and verify that the front panel ammeter indication is within 4% of 2.5 amps (6236B) or 1.0 amp (6237B).

j. Connect the DVM directly across the output terminals of the +6V (+18V) supply, record the DVM reading, and then open the switch in the 6V (18V) load circuit without disturbing the supply's output terminals. The DVM indication should not change by more than 2.6mV (6236B) or 3.8mV (6237B).

k. Check the rated output and ammeter accuracy of the +20V and -20V supplies similarly by connecting the test setup of Figure 5-3 to each output in turn. For each 20V supply: make the total resistance of R_L and the current sampling resistor 40 ohms, set the $\pm 20\text{V}$ VOLTAGE control for a current indication on the DVM of 0.5A, check that

the panel meter indication is within 4% of 0.5A, connect the DVM to the fully loaded output terminals, and compare the output voltage before and after the load circuit is opened. The voltage should not change by more than 4mV. While checking each supply, the other two must be fully loaded.

Current Limit

l. Disconnect all loads from the supply.

m. Connect the test setup shown in Figure 5-3 to the +20-volt output. Substitute a short for R_L and leave the load circuit switch open.

n. Set the voltage of the $\pm 20\text{V}$ supplies to 20 volts.

o. Close the load switch and determine the current flow through the current sampling resistor (meter shunt) by measuring its voltage drop with the DVM. The current should be $0.55\text{A} \pm 5\%$.

p. Check the current limit of the -20V supply in the same way. Its short-circuit current should also be $0.55\text{A} \pm 5\%$.

q. (Model 6237B only). Check the current limit of the +18V supply similarly by setting its output for 18 volts and using a DVM to measure the current which flows through a low-resistance current sampling resistor. The short-circuit current of the +18V supply should be $1.1\text{A} \pm 5\%$.

r. (Steps (r) through (t) apply to the 6236B only.) Connect the test setup shown in Figure 5-3 to the +6V output. Close the switch, set the total resistance of R_L and the current sampling resistor to an initial value of 2.4 ohms or greater, and set the output voltage to 6 volts.

s. Reduce the value of R_L gradually while observing the output current indicated by the DVM. The current should increase to a maximum of $2.75\text{A} \pm 5\%$ before it begins to decrease.

t. Connect a short across R_L and then recheck the current indicated by the DVM. The short-circuit current of this output should be $1\text{A} \pm 15\%$. Disconnect the test setup from the supply.

5-17 Load Effect (Load Regulation)

Definition: The change ΔE_{OUT} in the static value of dc output voltage resulting from a change in load resistance from open circuit to the value that yields maximum rated output current (or vice versa).

5-18 To check the load effect:

a. Connect a full load resistance and a digital voltmeter across the output of the +20V supply.

b. Turn on the supply and adjust its voltage to its maximum rated value.

c. Record the voltage indicated on the DVM.

d. Disconnect the load resistance and recheck the DVM indication. It should be within .01% plus 2mV of the reading in step (c).

e. Repeat steps (a) through (d) for each of the remaining supply outputs.

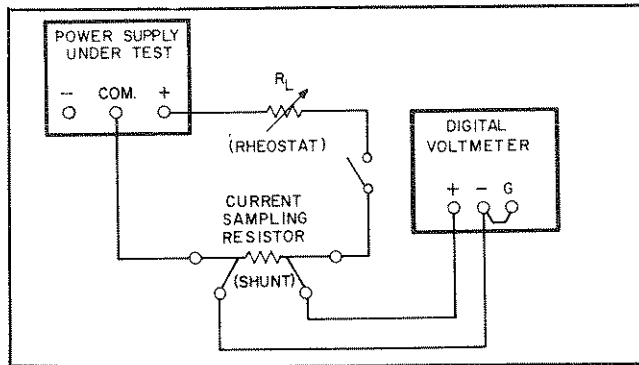

Figure 5-3. Output Current, Test Setup

5-19 Source Effect (Line Regulation)

Definition: The change, ΔE_{OUT} , in the static value of dc output voltage resulting from a change in ac input voltage over the specified range from low line (typically 104 Vac) to high line (typically 127 Vac), or from high line to low line.

5-20 To test the source effect:

- Connect a variable autotransformer between the input power source and the power supply line plug.
- Connect a full load resistance and a digital voltmeter across the output of the +20V supply.
- Adjust the autotransformer for a low line input.
- Turn on the power, adjust the output of the supply to its maximum rated voltage, and record the DVM indication.
- Adjust the autotransformer for a high line input and recheck the DVM indication. It should be within .01% plus 2mV of the reading in step (d).
- Repeat steps (b) through (e) for each of the remaining supply outputs.

5-21 PARD (Ripple and Noise)

Definition: The residual ac voltage that is superimposed on the dc output of a regulated power supply. Ripple and noise may be specified and measured in terms of its rms or peak-to-peak value.

5-22 Measurement Techniques. Figure 5-4A shows an incorrect method of measuring p-p ripple. Note that a continuous ground loop exists from the third wire of the input power cord of the supply to the third wire of the input power cord of the oscilloscope via the grounded power supply case, the wire between the negative output terminal of the power supply and the vertical input of the scope, and the grounded scope case. Any ground current circulating in this loop as a result of the difference in potential E_G between the two ground points causes an IR drop that is in series with the scope input. This IR drop, normally having a 60 Hz line frequency fundamental, plus any pickup on the unshielded leads interconnecting the power supply and scope, appears on the face of the CRT. The magni-

tude of this resulting signal can easily be much greater than the true ripple developed between the plus and minus output terminals of the power supply and can completely invalidate the measurement.

5-23 The same ground current and pickup problems can exist if an rms voltmeter is substituted in place of the oscilloscope in Figure 5-4. However, the oscilloscope display, unlike the true rms meter reading, tells the observer immediately whether the fundamental period of the signal displayed is 8.3 milliseconds (1/120 Hz) or 16.7 milliseconds (1/60 Hz). Since the fundamental ripple frequency present on the output of an HP supply is 120 Hz (due to full-wave rectification), an oscilloscope display showing a 120 Hz fundamental component is indicative of a "clean" measurement setup, while the presence of a 60 Hz fundamental usually means that an improved setup will result in a more accurate (and lower) value of measured ripple.

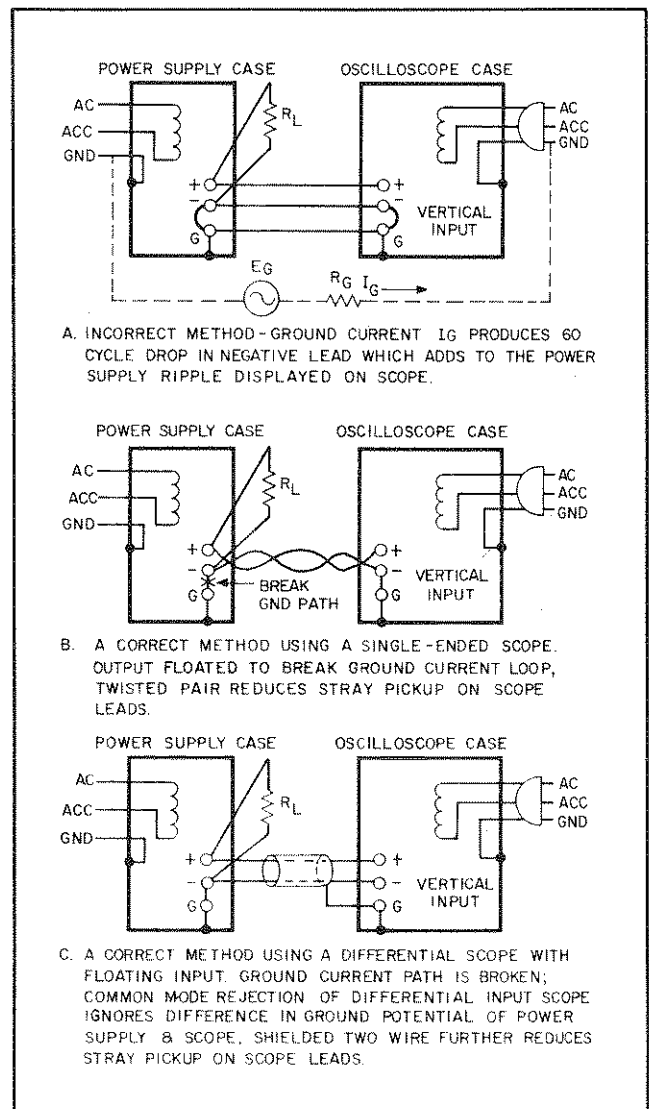

Figure 5-4. Ripple and Noise, Test Setup

5-24 Figure 5-4B shows a correct method of measuring the output ripple of a constant voltage power supply using a single-ended scope. The ground loop path is broken by floating the power supply output. To ensure that no potential difference exists between the supply and the oscilloscope, it is recommended that they both be plugged into the same ac power bus. If the same bus cannot be used, both ac grounds must be at earth ground potential.

5-25 Either a twisted pair or, preferably, a shielded two-wire cable should be used to connect the output terminals of the power supply to the vertical input terminals of the scope. When using a twisted pair, care must be taken that one of the two wires is connected to the grounded input terminal of the oscilloscope to ensure that the supply output is safely grounded. When using shielded two-wire, it is essential for the shield to be connected to ground at one end only to prevent ground current flowing through this shield from inducing a signal in the shielded leads.

5-26 To verify that the oscilloscope is not displaying ripple that is induced in the leads or picked up from the grounds, the (+) scope lead should be shorted to the (-) scope lead at the power supply terminals. The ripple value obtained when the leads are shorted should be subtracted from the actual ripple measurement.

5-27 In most cases, the single-ended scope method of Figure 5-4B will be adequate to eliminate extraneous ripple so that a satisfactory measurement may be obtained. However, in more stubborn cases (or if high frequency noise up to 20 MHz must be measured), it may be necessary to use a differential scope with floating input as shown in Figure 5-4C. If desired, two single-conductor shielded cables may be substituted in place of the shielded two-wire cable with equal success. Because of its common mode rejection, a differential oscilloscope displays only the difference in signal between its two vertical input terminals, thus ignoring the effects of any common mode signal produced by the difference in the ac potential between the power supply case and scope case. Before using a differential input scope in this manner, however, it is imperative that the common mode rejection capability of the scope be verified by shorting together its two input leads at the power supply and observing the trace on the CRT. If this trace is a straight line, then the scope is properly ignoring any common mode signal present. If this trace is not a straight line, then the scope is not rejecting the ground signal and must be realigned in accordance with the manufacturer's instructions until proper common mode rejection is attained.

5-28 **Measurement Procedure.** To measure the ripple and noise on each supply output, follow the steps below, If a high frequency noise measurement is desired, an oscil-

loscope with sufficient bandwidth (20 MHz) must be used. Ripple and noise measurements can be made at any input ac line voltage combined with any dc output voltage and load current within rating.

- Connect an oscilloscope or rms voltmeter across an output of the supply as shown in Figures 5-4B or 5-4C.
- Energize the supply and observe the oscilloscope or meter indication. The ripple and noise should not be greater than 0.35mV rms or 1.5mV peak-to-peak.
- Repeat for the remaining supply outputs.

5-29 Load Transient Recovery Time

Definition: The time "X" for output voltage recovery to within "Y" millivolts of the nominal output voltage following a "Z" amp step change in load current, where: "Y" equals 15mV, and "Z" is the specified load current change, equal to half of the current rating of the supply. The nominal output voltage is defined as the dc level halfway between the static output voltage before and after the imposed load change.

5-30 **Measurement Techniques.** Care must be taken in switching the load resistance on and off. A hand-operated switch in series with the load is not adequate since the resulting one-shot displays are difficult to observe on most oscilloscopes and the arc energy occurring during switching completely masks the display with a noise burst. Transistor load switching devices are expensive if reasonably rapid load

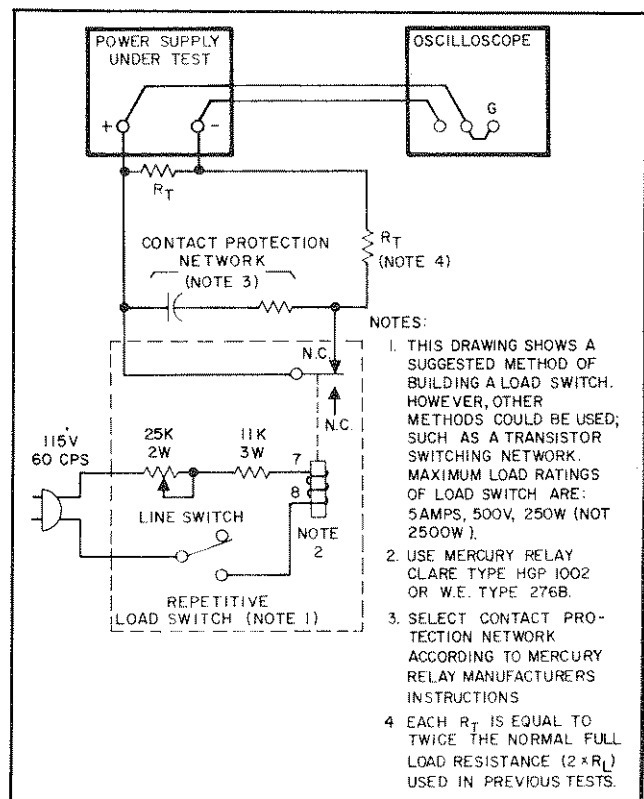

Figure 5-5. Load Transient Recovery Time, Test Setup

current changes are to be achieved. Instead, a mercury-wetted relay should be used for loading and unloading the supply. Connect it in the load switching circuit shown in Figure 5-5. When this load switch is connected to a 60 Hz ac input, the mercury-wetted relay will open and close 60 times per second. The 25K control adjusts the duty cycle of the load current switching to reduce jitter in the oscilloscope display. This relay may also be used with a 50 Hz ac input.

5-31 Measurement Procedure. To measure the load transient recovery time, follow the steps below for each supply output. Transient recovery time may be measured at any input line voltage and any output voltage within rating. For this supply the specified load change is between half load and full load.

- a. Connect the test setup shown in Figure 5-5. Both load resistors (R_T) are twice the normal value of a full load resistance.
- b. Turn on the supply and close the line switch on the repetitive load switch.
- c. Set the oscilloscope for internal sync and lock on either the positive or negative load transient spike.
- d. Set the vertical input of the oscilloscope for ac coupling so that small dc level changes in the output voltage of the power supply will not cause the display to shift.
- e. Adjust the horizontal positioning control so that the trace starts at a point coincident with a major graticule division. This point then represents time zero.
- f. Adjust the vertical centering of the scope so that the tail ends of the no-load and full-load waveforms are symmetrically displaced about the horizontal center line of the oscilloscope. This center line now represents the nominal output voltage defined in the specification.
- g. Increase the sweep rate so that a single transient spike can be examined in detail.

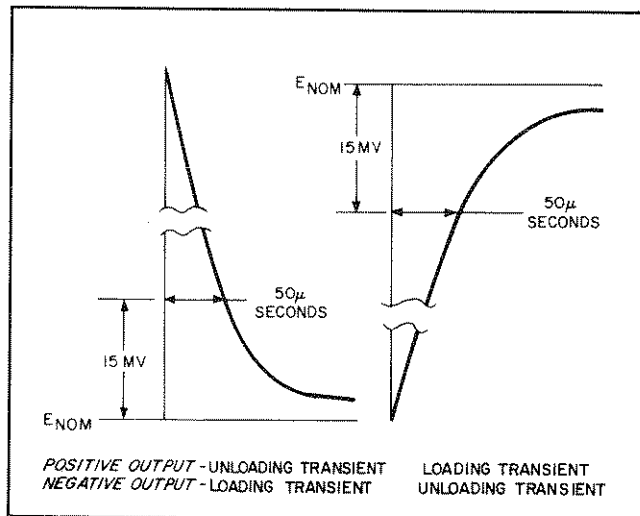

Figure 5-6. Load Transient Recovery Time Waveforms

- h. Adjust the sync controls separately for the positive and negative going transients so that not only the recovery waveshape but also as much as possible of the rise time of the transient is displayed.
- i. Starting from the major graticule division representing time zero, count to the right $50\mu s$ and vertically $15mV$. Recovery should be within these tolerances, as illustrated in Figure 5-6.

5-32 TROUBLESHOOTING

5-33 Before attempting to troubleshoot this instrument, ensure that the fault is in the instrument itself and not in an associated piece of equipment. You can determine this without removing the covers from the instrument by using the appropriate portions of the performance test of paragraph 5-6.

5-34 A good understanding of the principles of operation is a helpful aid in troubleshooting, and the reader is advised to review Section IV of the manual before beginning detailed troubleshooting. Once the principles of operation are understood, proceed to the initial troubleshooting procedures in paragraph 5-35.

CAUTION

Before applying power to the supply, make certain that its line voltage selector switch (S3) is set for the line voltage to be used. (See CAUTION notice in paragraph 3-2 for additional information on S3.)

5-35 Initial Troubleshooting Procedure

- 5-36** If a malfunction is found, follow the steps below:
- a. Disconnect input power from the supply and remove all loads from the output.
 - b. Table 5-2 lists the symptoms and probable causes of several possible troubles. If the symptom is one of those listed, make the recommended checks.
 - c. If none of the symptoms of Table 5-2 apply, proceed to Table 5-3. This table provides an initial troubleshooting procedure that also directs you to the more detailed procedures which follow it.

5-37 The numbered test points referred to in the troubleshooting procedures are identified on the circuit schematic and on the component location diagram at the rear of the manual.

5-38 Open Fuse Troubleshooting

5-39 Although transients or fatigue can cause a fuse to

Table 5-2. Miscellaneous Troubles

SYMPTOM	CHECK – PROBABLE CAUSE
High ripple	<ul style="list-style-type: none"> a. Check operating setup for ground loops (see paragraph 5-22). b. Check main rectifiers (CR11, CR12, CR31, CR32, CR51, CR52) for open. c. Supply may be operating in current limit mode. Check current limit adjustment, paragraph 5-26, steps (l) thru (t).
Will not current limit	Check for open OR-gate diodes (CR5, CR25, CR45) or defective current limit amplifier (U1, U2, U3).
Poor load or line regulation	<ul style="list-style-type: none"> a. Check bias and reference voltages, Table 5-4. b. Check main rectifiers and filters for opens.
Oscillation or poor transient recovery time	<ul style="list-style-type: none"> a. High frequency oscillations (above 50 kHz) can be caused by an open C4, C14, or C24. b. A defective output capacitor (C1, C11, or C21) can cause oscillations in one of many frequency ranges. c. Oscillation only in the current limiting mode can be caused by an open C3, C13, or C23.
Transient voltage overshoot at turn-on or turn-off.	<ul style="list-style-type: none"> a. Overshoot only in the –20V supply can be caused by a shorted Q13. b. Overshoot in all three supply outputs can be caused by an open Q14 or a shorted Q15.

Table 5-3. Initial Troubleshooting Procedure

STEP	ACTION	RESPONSE	NEXT ACTION
1	Check output voltage of +20V supply.	<ul style="list-style-type: none"> a. Normal b. Zero volts c. Output voltage lower or higher than rating. 	<ul style="list-style-type: none"> a. Proceed to step (2). b. Check ac line fuse (F1). If blown, proceed to paragraph 5-38. If not blown, check bias and reference voltages (Table 5-4). c. Check bias and reference voltages (Table 5-4).
2	Check output voltage of –20V supply in fixed tracking ratio mode.	<ul style="list-style-type: none"> a. Normal b. High, low, or zero output voltage. 	<ul style="list-style-type: none"> a. If +20V and –20V outputs are both normal with no load, a supply might be current limiting under load. To check this adjustment see paragraph 5-16, steps (l) thru (p). b. Proceed to –20V supply troubleshooting, Table 5-6.

Table 5-3. Initial Troubleshooting Procedure (Continued)

STEP	ACTION	RESPONSE	NEXT ACTION
3	Check output of +6V supply (Model 6236B) or +18V supply (Model 6237B).	<p>a. Normal</p> <p>b. High, low, or zero output voltage.</p>	<p>a. If the output of this supply is normal unloaded but its voltage falls when loaded, check the current limit adjustment, paragraph 5-16, steps (q) thru (t).</p> <p>b. Proceed to Table 5-7.</p>

Table 5-4. Bias and Reference Voltage Check

STEP	ACTION	RESPONSE	PROBABLE CAUSE
1	Check +7.5V bias, TP1 to common	<p>a. Normal (+7.5V \pm5%)</p> <p>b. Voltage high</p> <p>c. Voltage low</p>	<p>a. Proceed to step (2).</p> <p>b. Check VR3 for open.</p> <p>c. Check VR3 for short.</p> <p>Note: A short within U1, U2, U3, or U4 can cause low +7.5V or -12.4V bias voltages.</p>
2	Check -6.2V reference, TP2 to common	<p>a. Normal (-6.2V \pm5%)</p> <p>b. Voltage high</p> <p>c. Voltage low</p>	<p>a. Proceed to step (3).</p> <p>b. Check VR1 for open.</p> <p>c. Check VR1 and Q14 for short, VR2 and Q15 for open. (A short within U4 could reduce this voltage.)</p>
3	Check -12.4V bias, TP3 to common	<p>a. Normal (-12.4V \pm5%)</p> <p>b. High voltage</p> <p>c. Low voltage</p>	<p>a. Proceed to +20V supply troubleshooting. Table 5-5.</p> <p>b. Check Q11 for short, Q12 for open, and Z1 for open between pins 3 and 5.</p> <p>c. Check Q11 for open, Q12 for short, and Z1 for open between pins 1 and 3.</p>

Table 5-5. +20V Supply Troubleshooting

SYMPTOM	STEP – ACTION	RESPONSE – PROBABLE CAUSE
High output voltage (higher than rating)	<ol style="list-style-type: none"> 1. Attempt to turn down loop by shorting Q15 emitter-to-base 2. Measure voltage at output of OR-gate (TP4). 	<ol style="list-style-type: none"> a. If output voltage remains high, check Q1, Q15, and CR9 for short. b. If output voltage falls to near zero, remove short from Q15 and proceed to step (2). a. If TP4 is approx. $-0.7V$, check for open CR6 or R1, and defective U1. b. If TP4 is approx. $+0.7V$, check for defective Q2.
Low output voltage (lower than rating)	<ol style="list-style-type: none"> 1. Measure voltage at output of OR-gate (TP4). 2. Measure voltage at TP8. 3. Measure voltage at TP7. 4. Measure voltage at TP13. 	<ol style="list-style-type: none"> a. If TP4 is between zero and $-0.7V$, check for open Q1, Q15, R14, or CR59, and defective Q2. b. If TP4 is approx. $+0.7V$, proceed to step (2). a. If voltage at TP8 is positive, check Z1 for open between pins 5 and 13, check R8 for open, and check for defective R6 or U1. b. If TP8 is approx. $-0.7V$, proceed to step (3). a. If TP7 is approx. $+0.7V$, check CR6 for short. b. If TP7 is approx. $+1.4V$, proceed to step (4). a. If TP13 is approx. $-0.7V$, replace U1. b. If TP13 is zero volts, check for open R10, and shorted CR2 or CR3. c. If TP13 is approx. $+0.7V$, check for open R2, shorted R1, or leaky or shorted C2.

Table 5-6. -20V Supply Troubleshooting

SYMPTOM	STEP – ACTION	RESPONSE – PROBABLE CAUSE
High output voltage (more than 1% greater than +20V supply in fixed tracking ratio mode).	<ol style="list-style-type: none"> 1. Attempt to turn down loop by shorting Q13 emitter-to-base. 2. Measure voltage at output of OR-gate (TP5) 	<p style="text-align: center;">NOTE: The +20V supply must operate properly before troubleshooting the -20V supply.</p> <ol style="list-style-type: none"> a. If output voltage remains high, check Q3, CR29, and Q13 for short. b. If output falls to near zero, remove short from Q13 and proceed to step (2). a. If voltage at TP5 is zero or negative, check for defective Q4. b. If TP5 is positive, proceed to step (3)

Table 5-6. -20V Supply Troubleshooting (Continued)

SYMPTOM	STEP – ACTION	RESPONSE – PROBABLE CAUSE
	3. Measure voltage at TP14.	a. If TP14 is approx. $-0.7V$, check for open CR26 or defective U2. b. If TP14 is approx. $+0.7V$, check Z1 for open from pin 7 to 12 or for short from pin 6 to 12.
Low output voltage (more than 1% lower than +20V supply in fixed tracking ratio mode).	1. Measure voltage at TP5. 2. Measure voltage at TP9. 3. Measure voltage at TP10. 4. Measure voltage at TP14.	a. If voltage at TP5 is zero or positive, check for open Q3, Q13, or R34, and defective Q4. b. If TP5 voltage is approx. $-0.7V$, proceed to step (2). a. If TP9 is negative, check for open Z1 between pins 5 and 15, open R28, and defective R26 or U2. b. If TP9 is approx. $+0.7V$, proceed to step (3). a. If TP10 is approx. $-0.7V$, check CR26 for short. b. If TP10 is -1.0 to $-1.4V$, proceed to step (4). a. If TP14 is approx. $+0.7V$, replace U2. b. If TP14 is zero volts, check for shorted CR22 or CR23. c. If TP14 is approx. $-0.7V$, check Z1 for open between pins 6 and 12 or short between pins 7 and 12, and check for leaky or shorted C12.

Table 5-7. +6V or +18V Supply Troubleshooting

SYMPTOM	STEP – ACTION	RESPONSE – PROBABLE CAUSE
High output voltage (higher than rating)	1. Attempt to turn down loop by shorting Q15 emitter-to-base. 2. Measure voltage at output of OR-gate (TP6).	a. If output voltage remains high, check Q7, Q15, and CR49 for short. b. If output voltage falls to near zero, remove short from Q15 and proceed to step (2). a. If TP6 is approx. $-0.7V$, check for open CR46 or R41, and defective U3. b. If TP6 is approx. $+0.7V$, check for defective Q8.
Low output voltage (lower than rating)	1. Measure voltage at output of OR-gate (TP6).	a. If TP6 is between zero and $-0.7V$, check for open Q7, Q15, R54, or CR59, and defective Q8. b. If TP6 is approx. $+0.7V$, proceed to step (2).

Table 5-7. +6V or +18V Supply Troubleshooting (Continued)

SYMPTOM	STEP – ACTION	RESPONSE – PROBABLE CAUSE
	2. Measure voltage at TP12.	a. If voltage at TP12 is positive, check for shorted R49, open R48, open Z1 between pins 5 and 14, and defective R46 or U3.
	3. Measure voltage at TP11.	a. If TP11 is approx. +0.7V, check CR46 for short. b. If TP11 is approx. +1.4V, proceed to step (4).
	4. Measure voltage at TP15.	a. If TP15 is approx. –0.7V, replace U3. b. If TP15 is zero volts, check for open R50, and shorted CR42 or CR43. c. If TP15 is approx. +0.7V, check for shorted R41, open R42, or leaky or shorted C22.

blow, it is a good idea to inspect the unit for obvious shorts such as damaged wiring, charred components, or extraneous metal parts or wire clippings in contact with circuit board conductors before replacing the fuse. The rating of the correct replacement fuse depends on the line voltage option of the instrument: for Options 100 or 120, use a normal time-constant 2-amp fuse (HP Part No. 2110-0002); for Options 220 or 240, use a normal time-constant 1-amp fuse (HP Part No. 2110-0001).

5-40 REPAIR AND REPLACEMENT

5-41 Series Regulator Replacement

5-42 To remove and replace a series regulator transistor:

- Remove the top and bottom covers from the instrument.
- Remove the collector screws and unsolder the base and emitter leads from the board to remove the transistor.
- To replace the transistor, follow the below reassembly order, as viewed from the bottom of the heat sink: collector screws, P. C. board, heat sink, two insulating bushings (in collector screw holes in heatsink), silicon grease (Dow DC-5 or HP 8500-0059), mica insulator, another coating of silicon grease, transistor, lock-washers, and hex-nuts.
- Resolder the emitter and base pins to the circuit board.

5-43 Semiconductor Replacement

5-44 Table 6-4 contains replacement data for the semiconductors used in this power supply. When replacing a

semiconductor, use the listed Hewlett-Packard part or exact commercial replacement if these are available. If neither of these are immediately available and a part is needed without delay for operation or troubleshooting verification, the parts designated Note 1, Alternate Part Number can be tried with a high probability of success.

5-45 Notice that both the commercial and alternate replacements listed in Table 6-4 apply only to the HP power supplies covered by this manual and their use in any other Hewlett-Packard instrument is not necessarily recommended because of inclusion in this table.

5-46 ADJUSTMENT AND CALIBRATION

5-47 Current Limit Adjustment

5-48 $\pm 20V$ Supplies. Perform the following steps to adjust the current limit circuit in the +20V or –20V supply. Potentiometer R6 sets the +20V and R26 the –20V current limit.

- Turn the TRACKING RATIO control to the FIXED position.
- Turn the current limit adjustment pot (R6 or R26) fully counterclockwise to its minimum setting.
- Connect the test circuit of Figure 5-3 to the output of the supply to be adjusted. Use a 40 Ω 10W resistor for R_L .
- Turn on the supply and set the $\pm 20V$ VOLTAGE control for maximum output (fully clockwise).
- Turn the current limit pot (R6 or R26) slowly clockwise until the DVM indicates a voltage drop across the shunt corresponding to a current of 0.55A $\pm 5\%$.

5-49 +6V Supply (Model 6236B). To adjust the current limit circuit in the +6V supply, proceed as follows:

a. Check the setting of the current limit by performing steps (r) and (s) of paragraph 5-16. (Be sure to set the output voltage to 6 volts.) If reducing the load resistance permits the current to exceed 2.9A, stop, turn R46 slightly clockwise, and repeat the test. If, instead, the current begins to fall before it reaches 2.6A, turn R46 slightly counterclockwise and repeat the test.

b. Recheck the setting and readjust R46 until the test shows that the current limit circuit begins to reduce the current when a decreasing load resistance increases it to 2.75A \pm 5%.

5-50 +18V Supply (Model 6237B). To adjust the current limit circuit in the +18V supply, proceed as follows:

a. Turn current limit adjustment pot (R46) fully clockwise to its minimum setting.

b. Connect the test circuit of Figure 5-3 to the output of the +18V supply. Use an 18 Ω 20W resistor for R_L .

c. Turn on the supply and set the +18V VOLTAGE control for maximum output (fully clockwise).

d. Turn current limit pot (R46) slowly counterclockwise until the DVM indicates a voltage drop across the shunt corresponding to a current of 1.1A \pm 5%.

5-51 Meter Calibration

5-52 Panel Voltmeters. Check the accuracy of the panel voltmeter by performing steps (a), (b), and (c) of the procedure in paragraph 5-16. Since the same range resistors are

used in both 20-volt ranges, their accuracy will be the same. Adjust R58 so that the percentage error in the +6V range (or +18V range) is equal to the error in the 20-volt ranges. Turn R58 clockwise to increase the indications or counterclockwise to decrease them. If R58 cannot calibrate all voltmeter ranges to within the \pm 4% specification, check the values of the resistors in the voltmeter circuit.

5-53 Panel Ammeter. Check and calibrate the panel ammeter by following the steps below.

a. Connect the test setup shown in Figure 5-3 to the +6V (or +18V) output. Make the total resistance of R_L and the current sampling resistor 2.4 ohms (Model 6236B) or 18 ohms (6237B) to permit operating the supply at its full rated output. R_L should have a power rating of at least 20 watts.

b. Close the switch and set the +6V (+18V) VOLTAGE control so that the DVM indicates an output of 2.5A (6236B) or 1.0A (6237B).

c. Check and record the panel ammeter accuracy on the +6V or +18V range.

d. Check each of the 20-volt ammeter ranges similarly, using the same test setup but making R_L a 40 Ω 10W resistor and setting the voltage control for a 0.5A output current. Record the panel ammeter accuracy on each 20-volt range.

e. Turn R59 clockwise to increase the indications on all three ranges or counterclockwise to decrease them.

f. If R59 cannot calibrate all three ammeter ranges to within the \pm 4% specification, check the values of the resistors in the circuit, including current monitoring resistors R8, R28, and R48.

SECTION VI REPLACEABLE PARTS

6-1 INTRODUCTION

6-2 This section contains information for ordering replacement parts. Table 6-4 lists parts in alpha-numeric order by reference designators and provides the following information:

- a. Reference Designators. Refer to Table 6-1.
- b. Description. Refer to Table 6-2 for abbreviations.
- c. Total Quantity (TQ). Given only the first time the part number is listed except in instruments containing many sub-modular assemblies, in which case the TQ appears the first time the part number is listed in each assembly.
- d. Manufacturer's Part Number or Type.
- e. Manufacturer's Federal Supply Code Number. Refer to Table 6-3 for manufacturer's name and address.
- f. Hewlett-Packard Part Number.
- g. Recommended Spare Parts Quantity (RS) for complete maintenance of one instrument during one year of isolated service.
- h. Parts not identified by a reference designator are listed at the end of Table 6-4 under Mechanical and/or Miscellaneous. The former consists of parts belonging to and grouped by individual assemblies; the latter consists of all parts not immediately associated with an assembly.

6-3 ORDERING INFORMATION

6-4 To order a replacement part, address order or inquiry to your local Hewlett-Packard sales office (see lists at rear of this manual for addresses). Specify the following information for each part: Model, complete serial number, and any Option or special modification (J) numbers of the instrument; Hewlett-Packard part number; circuit reference designator; and description. To order a part not listed in Table 6-4, give a complete description of the part, its function, and its location.

Table 6-1. Reference Designators

A = assembly	E = miscellaneous electronic part
B = blower (fan)	F = fuse
C = capacitor	J = jack, jumper
CB = circuit breaker	K = relay
CR = diode	L = inductor
DS = device, signaling (lamp)	M = meter

Table 6-1. Reference Designators (Continued)

P = plug	V = vacuum tube, neon bulb, photocell, etc.
Q = transistor	VR = zener diode
R = resistor	X = socket
S = switch	Z = integrated circuit or network
T = transformer	
TB = terminal block	
TS = thermal switch	

Table 6-2. Description Abbreviations

A = ampere	mod. = modular or modified
ac = alternating current	mtg = mounting
assy. = assembly	n = nano = 10^{-9}
bd = board	NC = normally closed
bkt = bracket	NO = normally open
$^{\circ}$ C = degree Centigrade	NP = nickel-plated
cd = card	Ω = ohm
coef = coefficient	obd = order by description
comp = composition	OD = outside diameter
CRT = cathode-ray tube	p = pico = 10^{-12}
CT = center-tapped	P.C. = printed circuit
dc = direct current	pot. = potentiometer
DPDT = double pole, double throw	p-p = peak-to-peak
DPST = double pole, single throw	ppm = parts per million
elect = electrolytic	pvr = peak reverse voltage
encap = encapsulated	rect = rectifier
F = farad	rms = root mean square
$^{\circ}$ F = degree Fahrenheit	Si = silicon
fxd = fixed	SPDT = single pole, double throw
Ge = germanium	SPST = single pole, single throw
H = Henry	SS = small signal
Hz = Hertz	T = slow-blow
IC = integrated circuit	tan. = tantalum
ID = inside diameter	Ti = titanium
incnd = incandescent	V = volt
k = kilo = 10^3	var = variable
m = milli = 10^{-3}	ww = wirewound
M = mega = 10^6	W = Watt
μ = micro = 10^{-6}	
met. = metal	
mfr = manufacturer	

Table 6-3. Code List of Manufacturers

CODE	MANUFACTURER	ADDRESS
01121	Allen Bradley Co.	Milwaukee, WI
02114	Ferroxcube Corp.	Saugerties, NY
02582	Clarostat Mfg. Co., Inc.	Dover, NH
02735	Radio Corp. of America, Solid State and Receiving Tube Div.	Somerville, NJ
03508	G. E. Semiconductor Products Dept.	Syracuse, NY
04200	Sprague Electric Co.	North Adams, MA
04713	Motorola Semiconductor Prod. Inc.	Phoenix, AZ
05524	Dale Electronics Inc.	Columbus, NE
05820	Wakefield Engr. Inc.	Wakefield, MA
05917	Aktiebolaget Rifa	Bromma, Sweden
07716	IRC Div. of TRW Inc.	Burlington, IA

CODE	MANUFACTURER	ADDRESS
09353	C & K Components Inc.	Newton, MA
19701	Electra/Midland Corp.	Mineral Wells, TX
27014	National Semiconductor Corp.	Santa Clara, CA
28480	Hewlett-Packard Co.	Palo Alto, CA
61637	Union Carbide Corp.	New York, NY
71450	CTS Corp.	Elkhart, IN
72136	Electro Motive Mfg.Co., Inc.	Willimantic, CT
75042	IRC Div. of TRW, Inc.	Philadelphia, PA
75915	Littlefuse, Inc.	Des Plaines, IL

Table 6-4. Replaceable Parts

REF. DESIG.	DESCRIPTION	TQ *	MFR. PART NO.	MFR. CODE	HP PART NO.	RS
	Printed Circuit Board Assy.					
C1	fxd, elect 180 μ F 50V	2/3	672D047	04200	0180-0634	1
C2	fxd, tant 6.8 μ F 35V	3	150D685X9035B2	04200	0180-0116	1
C3, 4	fxd, polyester 2200pF 200V	2	292P22292-PTS	04200	0160-0154	1
C7	fxd, elect 1450 μ F 45V	2	(Type 68D) D39532	04200	0180-1893	1
C8, 9	fxd, cer. .05 μ F 400V	6/4	33C17A3-CDH	04200	0150-0052	1
C11	fxd, elect 180 μ F 50V		672D047	04200	0180-0634	
C12	fxd, tant 6.8 μ F 35V		150D685X9035B2	04200	0180-0116	
C13	fxd, polyester .01 μ F 200V	2	292P10392-PTS	04200	0160-0161	1
C14	fxd, polyester 3300pF 200V	1	292P33292-PTS	04200	0160-0155	1
C17	fxd, elect 1450 μ F 45V		(Type 68D) D39532	04200	0180-1893	
C18, 19	fxd, cer .05 μ F 400V		33C17A3-CDH	04200	0150-0052	
C21						
6236B	fxd, elect 1000 μ F 12V	1	627D046	04200	0180-0633	1
6237B	fxd, elect 180 μ F 50V		672D047	04200	0180-0634	
C22	fxd, tant 6.8 μ F 35V		150D685X9035B2	04200	0180-0116	
C23	fxd, cer .005 μ F 100V	1	C023B101E502MS27	04200	0160-2639	1
C24	fxd, polyester .01 μ F 200V		292P10392-PTS	04200	0160-0161	
C27						
6236B	fxd, elect 5600 μ F 25V	1	(Type 32D) D40018	04200	0180-1921	1
6237B	fxd, elect 3000 μ F 40V	1	32D5278-DQB	04200	0180-1899	1
C28, 29						
6236B	fxd, cer .05 μ F 400V		33C17A3-CDH	04200	0150-0052	
6237B	Not used					
C30						
6236B	Not used					
6237B	fxd, cer 0.1 μ F 500V	1	41C92B5-CDH	04200	0160-0269	1
C31						
6236B	fxd, tant 0.47 μ F 35V	1	150D474X9035A2	04200	0180-0376	1
6237B	fxd, elect 0.15 μ F 35V	1	T110A154K035AS	61637	0180-0218	1
C32	fxd, mica 330pF 500V	1	obd	72136	0160-2012	1
C33	fxd, elect 490 μ F 85V	1	(Type 68D) D38618	04200	0180-1888	1
C34	fxd, paper 0.1 μ F 250Vac	1	PME271-M-610	05917	0160-4065	1
CR1	Diode, Si 1A 200V	13/15	1N5059		1901-0327	7
CR2-7	Diode, Si	17	1N485B		1901-0033	7
CR9,11,12,21	Diode, Si 1A 200V		1N5059		1901-0327	
CR22-26	Diode, Si		1N485B		1901-0033	
CR28,29,31,32	Diode, Si 1A 200V		1N5059		1901-0327	
CR41	Diode, Si 1.5A 200V	3	1N4999		1901-0416	3
CR42, 43	Diode, Si		1N485B		1901-0033	
CR44	Diode, stabistor 150mA 15V	2	STB523	03508	1901-0460	2
CR45-47	Diode, Si		1N485B		1901-0033	
CR49	Diode, Si 1A 200V		1N5059		1901-0327	
CR51, 52	Diode, Si 1.5A 200V		1N4999		1901-0416	
CR53, 54						
6236B	Not used					
6237B	Diode, Si 1A 200V		1N5059		1901-0327	
CR55, 56	Diode, Si 1A 200V		1N5059		1901-0327	
CR57	Diode, stabistor 150mA 15V		STB523	03508	1901-0460	
CR59	Diode, Si 1A 200V		1N5059		1901-0327	

* 6236B/6237B

Table 6-4. Replaceable Parts (Continued)

REF. DESIG.	DESCRIPTION	TQ*	MFR. PART NO.	MFR. CODE	HP PART NO.	RS
CR60	Diode, Si		1N485B		1901-0033	
L1, 2, 3	Inductor, ferrite bead (Q2, Q3, CR49)	3	56-590-65/4A6	02114	9170-0894	1
Q2	SS NPN Si	3	SS1147 (Note 1)	04713	1854-0448	3
Q4	SS PNP Si	1	2N2904A		1853-0012	1
Q11	Power PNP Si	1	2N3740		1853-0052	1
Q12	SS NPN Si		SS1147 (Note 1)	04713	1854-0448	
Q13	SS PNP Si	1	2N4036		1853-0041	1
Q14	SS NPN Si	1	2N2714A		1854-0027	1
Q15	SS NPN Si		SS1147 (Note 1)	04713	1854-0448	
R1	var. 10k (VOLTAGE $\pm 20V$)	2	43X	02582	2100-3461	
R2	fxd, film 2.61k 1% 1/8W	1	Type MF4C, T-9	19701	0698-0092	1
R3	fxd, ww 0.1 10% 3W	2	RS-2B	05524	0811-1827	1
R4	fxd, comp 18 5% 1/2W	3	EB1805	01121	0686-1805	1
R6	var. ww 3k	3	Type 110-F4	71450	2100-1823	1
R8	fxd, ww 1.25 1/2% 5W	2	RS5	05524	0811-3384	1
R9	fxd, film 5.49k 1% 1/8W	1	Type MF4C, T-0	19701	0698-3382	1
R10	fxd, film 1.5k 1% 1/8W	1	Type MF4C, T-0	19701	0757-0427	1
R11	fxd, film 110k 1% 1/8W	2	Type MF4C, T-0	19701	0757-0466	1
R12	fxd, film 139 1% 1/8W	3	Type CEA, T-0	07716	0698-4099	1
R13	fxd, comp 15k 5% 1/2W	1	EB1535	01121	0686-1535	1
R14	fxd, comp 510 5% 1W	1	GB5115	01121	0689-5115	1
R15	fxd, comp 10k 5% 1/2W	2	EB1035	01121	0686-1035	1
R23	fxd, ww 0.25 10% 3W	1	RS-2B	05524	0811-1829	1
R24	fxd, comp 18 5% 1/2W		EB1805	01121	0686-1805	
R26	var. ww 3k		Type 110-F4	71450	2100-1823	
R28	fxd, ww 1.25 1/2% 5W		RS5	05524	0811-3384	
R32	fxd, film 139 1% 1/8W		Type CEA, T-0	07716	0698-4099	
R33	fxd, film 15k 1% 1/8W	2	Type MF4C, T-0	19701	0757-0446	1
R34	fxd, comp 510 5% 1/2W	1	EB5115	01121	0686-5115	1
R35	fxd, comp 10k 5% 1/2W		EB1035	01121	0686-1035	
R41	var, 10k (VOLTAGE +6V, or +18V)		43X	02582	2100-3461	
R42						
6236B	fxd, film 8.66k 1% 1/8W	1	Type MF4C, T-9	19701	0698-8076	1
6237B	fxd, film 2.87k 1% 1/8W	1	Type MF4C-1	19701	0698-7631	1
R43	fxd, ww 0.1 10% 3W		RS-2B	05524	0811-1827	
R44	fxd, comp 18 5% 1/2W		EB1805	01121	0686-1805	
R45						
6236B	Not used					
6237B	fxd, film 2k 1% 1/8W	1	CEA993	07716	0757-0283	1
R46	var. ww 3k		Type 110-F4	71450	2100-1823	
R47						
6236B	fxd, film 23k 1% 1/8W	1	Type MF4C, T-0	19701	0698-3269	1
6237B	Not used					
R48						
6236B	fxd, ww 0.25 1/2% 5W	1	RS5	05524	0811-3383	1
6237B	fxd, ww 0.625 1/2% 5W	1	RS5	05524	0811-3395	1
R49						
6236B	fxd, film 750 1% 1/8W	1	Type MF4C, T-0	19701	0757-0420	1
6237B	Not used					

Note 1: Alternate part number. See para. 5-43.

Table 6-4. Replaceable Parts (Continued)

REF. DESIG.	DESCRIPTION	TQ*	MFR. PART NO.	MFR. CODE	HP PART NO.	RS
R50						
6236B	fxd, film 330 1% 1/8W	1	Type MF4C, T-9	19701	0698-5663	1
6237B	fxd, film 3.83k 1% 1/8W	1	Type MF4C-1	19701	0698-3153	1
R51	fxd, film 110k 1% 1/8W		Type MF4C, T-0	19701	0757-0466	
R52	fxd, film 139 1% 1/8W		Type CEA, T-0	07716	0698-4099	
R53	fxd, comp 7.5k 5% 1/2W	1	EB7525	01121	0686-7525	1
R54						
6236B	fxd, ww 50 5% 10W	1	Type 247E	04200	0811-1902	1
6237B	fxd, ww 135 5% 10W	1	Type 247E	04200	0811-1905	1
R55						
6236B	fxd, comp 2.2k 5% 1/2W	1	EB2225	01121	0686-2225	1
6237B	fxd, comp 11k 5% 1/2W	1	EB1135	01121	0686-1135	1
R56	fxd, film 270 1% 1/8W	1	Type CEA, T-0	07716	0757-0269	1
R57	fxd, film 221k 1% 1/8W	1	Type MF4C, T-0	19701	0757-0473	1
R58, 59	var. ww 250	2	Type 110	71450	2100-0439	1
R60	fxd, film 15k 1% 1/8W		Type MF4C, T-0	19701	0757-0446	
R61	fxd, comp 240 5% 1/2W	1	EB2415	01121	0686-2415	1
R62	fxd, film 11k 1% 1/8W	2	Type MF4C, T-0	19701	0757-0443	1
R63	fxd, film 3.6k 2% 1/8W	1	Type MF4C, T-0	19701	0757-0937	1
R64	fxd, film 11k 1% 1/8W		Type MF4C, T-0	19701	0757-0443	
R65	fxd, film 16.2k 1% 1/8W	1	Type MF4C, T-0	19701	0757-0447	1
R66	fxd, film 470 1% 1/4W	1	Type MF52C, T-0	19701	0698-3506	1
R67						
6236B	fxd, ww 135 5% 3W	1	Type 242E	04200	0812-0112	1
6237B	fxd, ww 220 5% 2W	1	Type BWH	75042	0811-1763	1
R68						
6236B	fxd, ww 250 5% 3W	1	Type 242E	04200	0811-1219	1
6237B	fxd, ww 490 5% 3W	1	Type 242E	04200	0811-1801	1
R69						
6236B	fxd, ww 100 5% 10W	1	Type 247E	04200	0811-1903	1
6237B	fxd, ww 150 5% 10W	1	Type 247E	04200	0811-1906	1
R70						
6236B	fxd, ww 40 5% 5W	1	Type 243E	04200	0812-0083	1
6237B	fxd, ww 75 5% 5W	1	RS5	05524	0812-0097	1
R71	fxd, film 471 1% 1/8W	1	Type CMF-55-1, T-1	05524	0698-5514	1
R72	fxd, comp 33k 5% 1/2W	1	EB3335	01121	0686-3335	1
R73, 6236B	Not used					
6237B	fxd, comp 1.1m 5% 1/2W	1	EB1155	01121	0686-1155	1
R74						
6236B	(jumper installed)					
6237B	fxd, film 6.98k 1% 1/8W	1	Type CMF-55-1, T-1	05524	0698-4470	1
R76	fxd, ww 10k, 5%, 3W	1	RS-2B	05524	0811-1816	1
S3	slide switch, dual DPDT	1		28480	3101-1914	1
T1	Power Transformer			28480	06236-80091	
U1-3	Dual op amp, IC	3	CA 3458T (Note 1)	02735	1826-0092	3
U4	Operational amp, IC	1	LM301AH	27014	1820-0223	1
VR1	Diode, zener 6.2V	1	1N825		1902-1221	1
VR2	Diode, zener 9.09V	1	SZ 10939-170	04713	1902-3149	1
VR3	Diode, zener 7.5V	1	1N4353B		1902-0650	1
Z1	Resistor network	1		28480	1810-0217	1

Note 1: Alternate part number. See para. 5-43.

Table 6-4. Replaceable Parts (Continued)

REF. DESIG.	DESCRIPTION	TQ*	MFR. PART NO.	MFR. CODE	HP PART NO.	RS
DS1	Front Panel - Electrical Indicator light, LINE ON	1		28480	1450-0566	1
M1						
6236 B	Voltmeter, 0-25V	1		28480	1120-1380	1
6237 B	Voltmeter, 0-25V	1		28480	1120-1382	1
M2						
6236 B	Ammeter, 0-3A	1		28480	1120-1381	1
6237 B	Ammeter, 0-1.2A	1		28480	1120-1383	1
S1	Toggle Switch, LINE ON	1	7318-PHI	09353	3101-1694	1
S2	3-position rotary switch, METER	1		28480	3100-1943	1
R77	var. 10k (TRACKING RATIO)	1		28480	2100-3656	
F1	Rear Heatsink - Electrical Fuse, 2A 250V (Std. Option and Option 100)	1	312002	75915	2110-0002	5
F1	Fuse, 1A 250V (Options 220 and 240)	1	312001	75915	2110-0001	5
Q1, 7	Power PNP Si	2	SJ1528	04713	1853-0063	2
Q3, 8	Power NPN Si	2	2N3055 (Note 1)		1854-0563	2
	Circuit Board - Mechanical Heat Dissipator (CR51, 52, Q2, Q11 in 6236B; Q2 in 6237B)	4/1	207-CB	05820	1205-0033	
	Heat Sink (Q11)	1		28480	5000-6025	
	Spacer (for Q11 heatsink)	2		28480	0380-0004	
	Rubber bumper	4		28480	0403-0086	
	Front Panel - Mechanical Binding Post, red	4		28480	1510-0091	
	Binding Post, black	1		28480	1510-0107	
	Meter bezel	2		28480	4040-0571	
	Spring, compression (meter mount)	8		28480	1460-0720	
	Retainer, push-on (for DSI)	1		28480	0510-0123	
	Knob (R1, R41, R77, S2)	4		28480	0370-1099	
	Miscellaneous Bushing, transistor insulator	8		28480	0340-0168	
	Transistor insulator, mica	4		28480	0340-0174	
	Fuse holder	1	342014	75915	1400-0084	
	Lockwasher, fuseholder	1		28480	2190-0054	
	Nut, nylon 1/2 - 24	1		28480	2950-0131	
	Foot, rubber	4		28480	0403-0088	
	Line cord strain relief	1		28480	0400-0013	
	Line cord	1			see par. 2-21	
	Chassis assembly, left	1		28480	5060-7955	
	Chassis assembly, right	1		28480	5060-7956	
	Front panel (6236B)	1		28480	06236-00001	
	Front panel (6237B)	1		28480	06237-00001	
	Heat sink, rear	1		28480	5020-8423	
	Cover, top and bottom	2		28480	5000-9424	
	Packing carton	1		28480	9211-2518	
	Floater pad, packing carton	2		28480	9220-1218	

Note 1: Alternate part number. See para. 5-43.

SECTION VII CIRCUIT DIAGRAMS

7-1 COMPONENT LOCATION DIAGRAM

7-3 SCHEMATIC DIAGRAM

7-2 The component location diagram for power supply Models 6236B and 6237B is given below. The illustration shows the physical locations and reference designations of parts mounted on the printed circuit card. (Not all parts are used in both models.)

7-4 Figure 7-1 is a combined schematic diagram of the 6236B and 6237B. The test points (circled numbers) shown on the schematic correspond to those on the component location diagram and in the troubleshooting procedure in Section V. The tinted areas on the schematic indicate components and jumpers used in one model only.

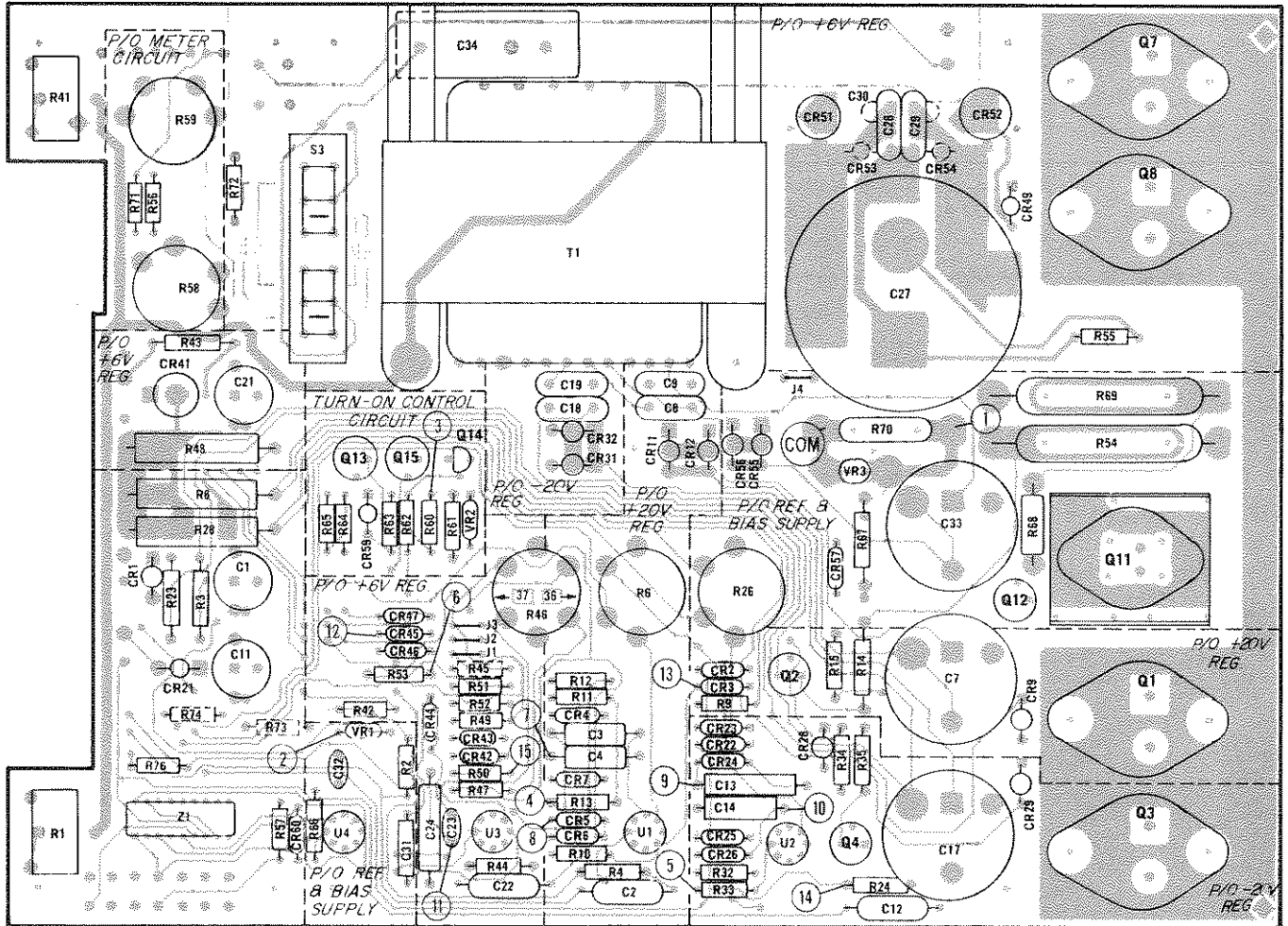

Models 6236B and 6237B, Component Locations

SCHEMATIC NOTES

1. ALL COMPONENTS ARE LOCATED ON P.C. BOARD, UNLESS OTHERWISE INDICATED.
2. † DENOTES CHASSIS MOUNTED COMPONENTS.
3. ——— DENOTES CONSTANT VOLTAGE FEEDBACK PATH.
4. ——— DENOTES CURRENT LIMIT FEEDBACK PATH.
5. ALL RESISTORS IN OHMS, 1/8W 1%, UNLESS OTHERWISE INDICATED.
6. THE SQUARE PLATED PADS ON THE P.C. BOARD INDICATE ONE OF THE FOLLOWING:
 - A. PIN 1 OF AN I.C. OR TRANSFORMER
 - B. POSITIVE END OF A POLARIZED CAPACITOR
 - C. CATHODE OF A DIODE OR EMITTER OF A TRANSISTOR
7. IN RESISTOR NETWORK Z1: Z1-J AND Z1-K ARE MATCHED TO WITHIN 1%, AND Z1-L AND Z1-M ARE MATCHED TO WITHIN 0.5% AND TRACK WITHIN ±50 PPM/°C.
8. FOR 100V OR 120V OPERATION USE A 2A FUSE, HP PART NO. Z110-0002; FOR 220V OR 240V OPERATION USE A 1A FUSE, HP PART NO. Z110-0001.
9. THE LOCATION AND PART NO. OF R46 IS THE SAME FOR MODELS 6236B AND 6237B BUT ITS ORIENTATION ON THE BOARD DIFFERS.
10. THE TINT AREAS ON THE SCHEMATIC INDICATE COMPONENTS AND JUMPERS THAT ARE USED IN ONE MODEL ONLY.

II. PIN LOCATIONS FOR TRANSISTORS ARE SHOWN BELOW:

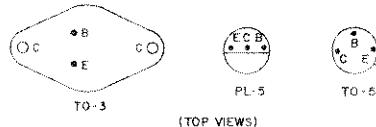

12. PIN LOCATIONS FOR INTEGRATED CIRCUITS AND THE RESISTOR NETWORK ARE SHOWN BELOW:

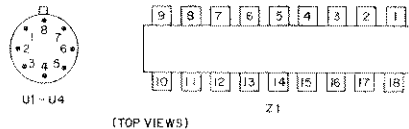

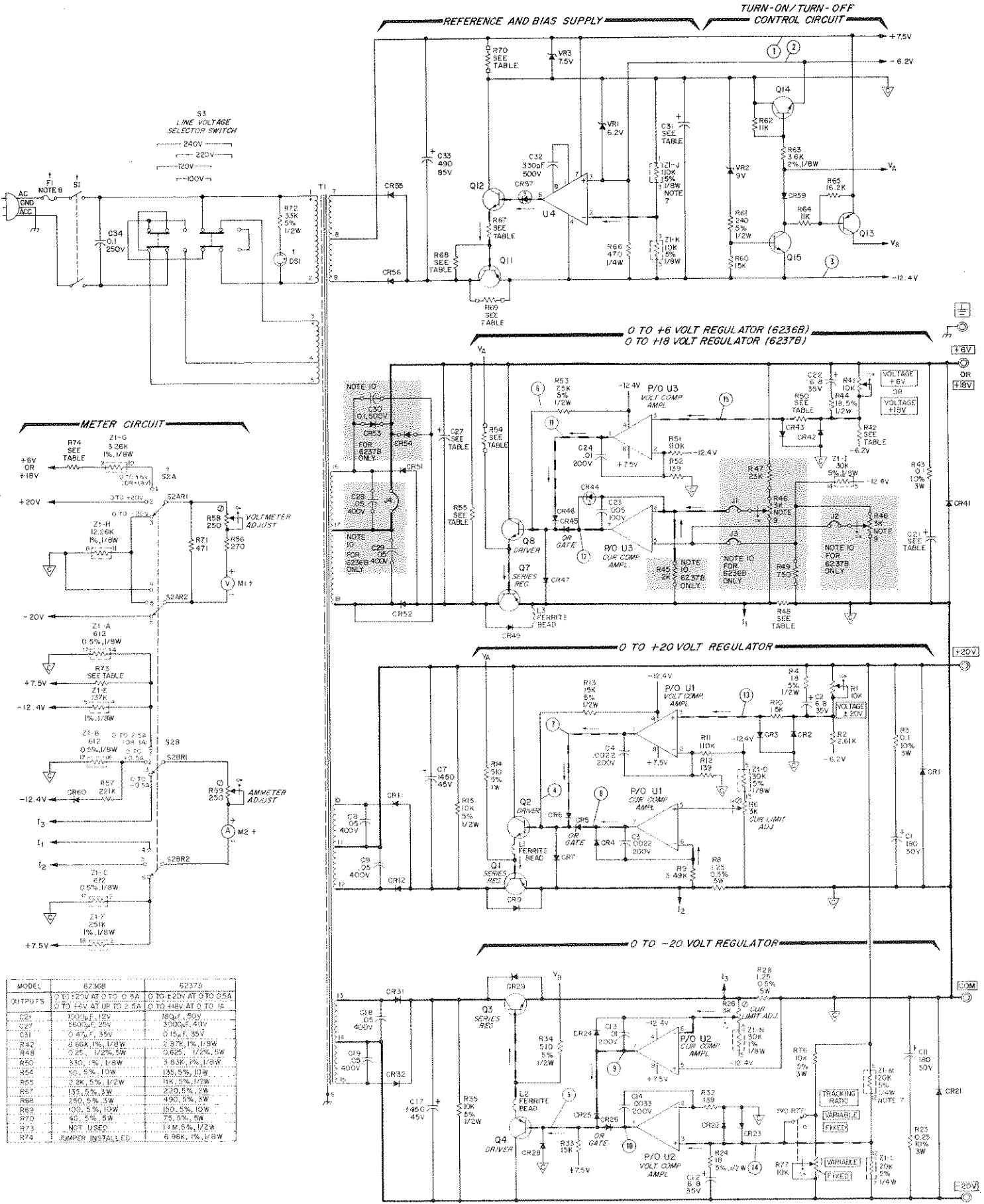

MODEL	6236B	6237B
OUTPUTS	0 TO +6V AT UP TO 0.5A 0 TO +18V AT UP TO 2.5A	0 TO +20V AT 0 TO 0.5A 0 TO +18V AT 0 TO 1A
C21	1000-1 10V	1000-1 10V
C27	5000-1 25V	3000-1 40V
C31	0.47 35V	0.15 35V
R42	8.66K 1% 1/8W	2.87K 1% 1/8W
R48	0.25 1/2% 5W	0.625 1/2% 5W
R50	340 1% 1/8W	8.93K 1% 1/8W
R54	75 5% 10W	185.5% 10W
R55	2.2K 5% 1/2W	14K 5% 1/2W
R67	135 5% 3W	220 5% 2W
R88	250 5% 3W	490 5% 3W
R89	100 5% 10W	150 5% 10W
R70	40 5% 5W	75 5% 5W
R73	NOT USED	1.8M 5% 1/2W
R74	JUMPER INSTALLED	8.98K 1% 1/8W

Figure 7-1. Models 6236B and 6237B, Schematic Diagram

APPENDIX A MANUAL BACKDATING CHANGES

To adapt this manual to Model 6236A or 6237A instruments, make the changes indicated in the table below.

MODEL	SERIAL NUMBERS	MAKE CHANGES
6236A	ALL	1
	1507A-00141 thru -00350	2
	1436A-00101 thru -00127	3
6237A	ALL	1
	1511A-00101 thru -00170	2

CHANGE 1:

Delete R76, R77, and all references to the variable tracking ratio feature.

CHANGE 2:

Change potentiometers R1 and R41 to 10k Ω panel-mounted type, HP Part No. 2100-1854.

CHANGE 3:

Delete ferrite bead L3, 9170-0894, from the lead of diode CR49.

EUROPE, NORTH AFRICA AND MIDDLE EAST

AUSTRIA
Hewlett-Packard Ges.m.b.H.
Handelskai 52
P.O. Box 7
A-1205 Vienna
Tel: (01) 25120-23
Cable: HEWPAK Vienna
Telex: 75923 hewpak a

BELGIUM
Hewlett-Packard Benelux
S.A./N.V.
Avenue du Col-Vert, 1.
(Grootkraaijan)
B-1170 Brussels
Tel: (02) 660 0047, 672-2240
Cable: PALOEN Brussels
Telex: 23-494 paloben br

CYPRUS
Kypricos
19 Gregorios Xenopoulos Street
P.O. Box 1152
Nicosia
Tel: 45628/29
Cable: Kypricos Pandeios
Telex: 3018

CZECHOSLOVAKIA
Vývojová a Provozní Závodna
Výzkumných Ústavů v Brněch
ČSSR-25097 Bechovice u Prahy
P.O. Box 1123
Tel: 89 33 41
Telex: 121333

Institute of Medical Biometrics
Býskumny Ústav Lekárskej Bioligy
Jedlova 6
IS-88346
Bratislava-Kramare
Tel: 4251
Telex: 93229

DDR
Entwicklungslabor der TU Dresden
Forschungsinstitut Meinsberg
DDR-7305
Waldheim/Meinsberg
Tel: 37 867
Telex: 518741

Export Contact AG Zurich
Guesenberger Fargasse
Schlegelstrasse 15
1040 Berlin
Tel: 42-74-12
Telex: 111889

DENMARK
Hewlett-Packard A/S
Ostavej 52
DK-3450 Birkerød
Tel: (02) 81 85 40
Cable: HEWPAK AS
Telex: 37409 hpa dk
Hewlett-Packard A/S
Naveri 1
DK-8600 Silkeborg
Tel: (05) 82 71 65
Telex: 37409 hpa dk
Cable: HEWPAK AS

EGYPT
I.E.A.
International Engineering Associates
24 Hassan Hegazi Street
Kast-el-Aini
Cairo
Tel: 23 829
Telex: 2067
Cable: INTENGASSO
Mohamed Sami Amin
Sami Amin Trading Office
18 Abdel Aziz Gawish
Abdine-Cairo
Tel: 24532
Cable: SAMIRO CAIRO

FINLAND
Hewlett-Packard Oy
Nahkonhuusintie 5
P.O. Box 5
SF-00211 Helsinki 21
Tel: (90) 6923031
Cable: HEWPAKOVY Helsinki
Telex: 12-1563 HEWPA SF

FRANCE
Hewlett-Packard France
Quartier de Courcouronnes
Boite Postale No. 6
F-91401 Orsay Cedex
Tel: (1) 907 78 25
Cable: HEWPAK Oisay
Telex: 690646
Hewlett-Packard France
Bureau de vente de Lyon
"Le Saquin"
Chemin des Mouilles
B.P. 15
F-69139 Ecullay Cedex
Tel: (78) 33 81 25
Cable: HEWPAK Ecullay
Telex: 31 06 17
Hewlett-Packard France
Bureau de vente de Marseille
Place Rouée de Villeneuve
F-13100 Aix-en-Provence
Tel: (42) 59 41 02
Cable: HEWPAK MARGN
Telex: 410770
Hewlett-Packard France
Centre d'affaires Paris-Nord
Bâtiment Ampère
Rue de la Commune de Paris
B.P. 300
F-93153 La Blanc Meauil Cédex
Tel: (01) 931 88 50
Hewlett-Packard France
Bureau de vente de Bordeaux
Av. du Pdt. Kennedy
E-33789 Mérignac
Tel: (56) 97 22 69

HUNGARY
MTA
Miskolcay és Mérésztchnikai
Szolgálat
Hewlett-Packard Service
Lenn Krt. 67. P.O. Box 24
1391 Budapest VI
Tel: 47 03 38
Telex: 22 51 14

ICELAND
Medical Only
Elding Trading Company Inc.
Hafnarvegur 11
Reykjavik
Tel: 1 58 201 63 03
Cable: ELIDING Reykjavik

IRELAND
Hewlett-Packard Ltd
King Street Lane
GB-Winnerah, Wokingham
Berks, RG11 5AR
Tel: (0734) 78 47 74
Telex: 847178
Cable: Hewpie London

ITALY
Hewlett-Packard Italiana S.p.A.
Via Amerigo Vesputci 2
Casella postale 3645
I-20124 Milano
Tel: (02) 6251 (10 lines)
Cable: HEWPAK Milano
Telex: 32046
Hewlett-Packard Italiana S.p.A.
Via Pellicci 5
I-35100 Padova
Tel: (049) 59 49 88
Telex: 41612 Hewpakie
Hewlett-Packard Italiana S.p.A.
Via G. Armani 10
I-00143 Roma
Tel: (06) 54 89 61
Telex: 61514
Cable: HEWPAKIT Roma
Hewlett-Packard Italiana S.p.A.
Conso Giovanni Lanca 94
I-10133 Torino
Tel: (011) 682245/659308
Medical/Calculators Only
Hewlett-Packard Italiana S.p.A.
Via Principe Nicola 43 G.C.
I-40137 Bologna
Tel: (059) 37 05 04
Hewlett-Packard Italiana S.p.A.
Via Amerigo Vesputci, 9
I-80142 Napoli
Tel: (081) 33 77 11
Telex: 61.51.4 Via Roma
Hewlett-Packard Italiana S.p.A.
Via E. Masi, 9/B
I-40137 Bologna
Tel: (051) 30 78 87

JORDAN
Moussier Cousins Co.
P.O. Box 1387
Amman
Tel: 24907/3907
Cable: SARCO JO 1456
Cable: MOUASHERCO

KUWAIT
Al-Khalidya Trading &
Contracting
P.O. Box 636-Safat
Kuwait
Tel: 42 4910/41 1726
Telex: 2481 Araep Kt
Cable: VISCOUNI

LUXEMBURG
Hewlett-Packard Benelux
S.A./N.V.
Avenue du Col-Vert, 1
(Grootkraaijan)
B-1170 Brussels
Tel: (02) 660 0047
Cable: PALOEN Brussels
Telex: 23 494

MOROCCO
Dolbaue
81 Rue Karattchi
Casablanca
Tel: 22 41 82/87
Telex: 23051/22833
Cable: MATERIO
Genee
190 Blvd. Brahim Roudani
Casablanca
Tel: 15 26 76/25 90 99
Telex: 22 793
Cable: GEREP-CASA
Coppedir
2 Rue d'Agadir, B.P. 156
Casablanca
Tel: 27 65 40
Telex: 21 737
Cable: DODEDIR

NETHERLANDS
Hewlett-Packard Benelux N.V.
Van Heuven Goedhartstraat 121
P.O. Box 687
NL-Amstelveen 1134
Tel: (020) 47 20 21
Cable: PALOEN Amsterdam
Telex: 13 216 hepa nl

NETHERLANDS
Hewlett-Packard Benelux N.V.
Van Heuven Goedhartstraat 121
P.O. Box 687
NL-Amstelveen 1134
Tel: (020) 47 20 21
Cable: PALOEN Amsterdam
Telex: 13 216 hepa nl

NETHERLANDS
Hewlett-Packard Benelux N.V.
Van Heuven Goedhartstraat 121
P.O. Box 687
NL-Amstelveen 1134
Tel: (020) 47 20 21
Cable: PALOEN Amsterdam
Telex: 13 216 hepa nl

NETHERLANDS
Hewlett-Packard Benelux N.V.
Van Heuven Goedhartstraat 121
P.O. Box 687
NL-Amstelveen 1134
Tel: (020) 47 20 21
Cable: PALOEN Amsterdam
Telex: 13 216 hepa nl

NORWAY
Hewlett-Packard A/S
Osloveien 16
P.O. Box 34
N-1345 Osteras
Tel: (02) 1711 80
Telex: 16621 hpnas n
Hewlett-Packard A/S
Bjuro Informacij Techniczej
Ul. Stawki 2, 6P
00-950 Warszawa
Tel: 33 25 88/88 67 43
Telex: 61 24 53 hepa pl
UNIPAN
Biuro Obslugi Techniczej
01-447 Warszawa
ul. Nowelska 9
Poland
Zaklady Naprawy Sprzetu
Medycznego
Plac Komuny Paryskiej 6
90-007 Lodz
Tel: 334-41, 337-83
Telex: 868981

PORTUGAL
Telegra-Empresa Técnica de
Equipamentos Electricos S. r. l.
Rua Rodrigo da Fonseca 103
P.O. Box 2531
P-Lisbon 1
Tel: (1) 91 89 72
Cable: ELECTRA Lisbon
Telex: 12598
Medical only
Mondinter
Intercombio Mundial de Comercio
S.r.l.
P.O. Box 2761
Avenida Antonio Augusto
136
P. L. Lisbon
Tel: (1) 91 53 21 31/7
Telex: 16691 munter p
Cable: INTERCOMBIO Lisbon

ROMANIA
Hewlett-Packard Reprezentanta
Bd. n. Balescu 16
Bucuresti
Tel: 15 80 23/13 88 95
Telex: 16 0440
I.L.R.U.
Intreprinderea Pantru
Intrelinare
Si Reparatara Unghiilor de Casul
Mamout Biser Street, 56-59
Bucuresti-Sectorul 2
Tel: 88-20-70, 88-24-40, 88-67-95
Telex: 116

SAUDI ARABIA
Modern Electronic
Establishment (Head Office)
P.O. Box 1238, Baghdadah Street
Jeddah
Tel: 27 798
Telex: 40938
Cable: ELECTA JEDDAH
Modern Electronic
Establishment (Branch)
P.O. Box 2726
Tel: 23051/22833
Cable: MATERIO
Genee
190 Blvd. Brahim Roudani
Casablanca
Tel: 15 26 76/25 90 99
Telex: 22 793
Cable: GEREP-CASA
Coppedir
2 Rue d'Agadir, B.P. 156
Casablanca
Tel: 27 65 40
Telex: 21 737
Cable: DODEDIR

SAUDI ARABIA
Modern Electronic
Establishment (Head Office)
P.O. Box 1238, Baghdadah Street
Jeddah
Tel: 27 798
Telex: 40938
Cable: ELECTA JEDDAH
Modern Electronic
Establishment (Branch)
P.O. Box 2726
Tel: 23051/22833
Cable: MATERIO
Genee
190 Blvd. Brahim Roudani
Casablanca
Tel: 15 26 76/25 90 99
Telex: 22 793
Cable: GEREP-CASA
Coppedir
2 Rue d'Agadir, B.P. 156
Casablanca
Tel: 27 65 40
Telex: 21 737
Cable: DODEDIR

SAUDI ARABIA
Modern Electronic
Establishment (Head Office)
P.O. Box 1238, Baghdadah Street
Jeddah
Tel: 27 798
Telex: 40938
Cable: ELECTA JEDDAH
Modern Electronic
Establishment (Branch)
P.O. Box 2726
Tel: 23051/22833
Cable: MATERIO
Genee
190 Blvd. Brahim Roudani
Casablanca
Tel: 15 26 76/25 90 99
Telex: 22 793
Cable: GEREP-CASA
Coppedir
2 Rue d'Agadir, B.P. 156
Casablanca
Tel: 27 65 40
Telex: 21 737
Cable: DODEDIR

SAUDI ARABIA
Modern Electronic
Establishment (Head Office)
P.O. Box 1238, Baghdadah Street
Jeddah
Tel: 27 798
Telex: 40938
Cable: ELECTA JEDDAH
Modern Electronic
Establishment (Branch)
P.O. Box 2726
Tel: 23051/22833
Cable: MATERIO
Genee
190 Blvd. Brahim Roudani
Casablanca
Tel: 15 26 76/25 90 99
Telex: 22 793
Cable: GEREP-CASA
Coppedir
2 Rue d'Agadir, B.P. 156
Casablanca
Tel: 27 65 40
Telex: 21 737
Cable: DODEDIR

SAUDI ARABIA
Modern Electronic
Establishment (Head Office)
P.O. Box 1238, Baghdadah Street
Jeddah
Tel: 27 798
Telex: 40938
Cable: ELECTA JEDDAH
Modern Electronic
Establishment (Branch)
P.O. Box 2726
Tel: 23051/22833
Cable: MATERIO
Genee
190 Blvd. Brahim Roudani
Casablanca
Tel: 15 26 76/25 90 99
Telex: 22 793
Cable: GEREP-CASA
Coppedir
2 Rue d'Agadir, B.P. 156
Casablanca
Tel: 27 65 40
Telex: 21 737
Cable: DODEDIR

SAUDI ARABIA
Modern Electronic
Establishment (Head Office)
P.O. Box 1238, Baghdadah Street
Jeddah
Tel: 27 798
Telex: 40938
Cable: ELECTA JEDDAH
Modern Electronic
Establishment (Branch)
P.O. Box 2726
Tel: 23051/22833
Cable: MATERIO
Genee
190 Blvd. Brahim Roudani
Casablanca
Tel: 15 26 76/25 90 99
Telex: 22 793
Cable: GEREP-CASA
Coppedir
2 Rue d'Agadir, B.P. 156
Casablanca
Tel: 27 65 40
Telex: 21 737
Cable: DODEDIR

SAUDI ARABIA
Modern Electronic
Establishment (Head Office)
P.O. Box 1238, Baghdadah Street
Jeddah
Tel: 27 798
Telex: 40938
Cable: ELECTA JEDDAH
Modern Electronic
Establishment (Branch)
P.O. Box 2726
Tel: 23051/22833
Cable: MATERIO
Genee
190 Blvd. Brahim Roudani
Casablanca
Tel: 15 26 76/25 90 99
Telex: 22 793
Cable: GEREP-CASA
Coppedir
2 Rue d'Agadir, B.P. 156
Casablanca
Tel: 27 65 40
Telex: 21 737
Cable: DODEDIR

SAUDI ARABIA
Modern Electronic
Establishment (Head Office)
P.O. Box 1238, Baghdadah Street
Jeddah
Tel: 27 798
Telex: 40938
Cable: ELECTA JEDDAH
Modern Electronic
Establishment (Branch)
P.O. Box 2726
Tel: 23051/22833
Cable: MATERIO
Genee
190 Blvd. Brahim Roudani
Casablanca
Tel: 15 26 76/25 90 99
Telex: 22 793
Cable: GEREP-CASA
Coppedir
2 Rue d'Agadir, B.P. 156
Casablanca
Tel: 27 65 40
Telex: 21 737
Cable: DODEDIR

SAUDI ARABIA
Modern Electronic
Establishment (Head Office)
P.O. Box 1238, Baghdadah Street
Jeddah
Tel: 27 798
Telex: 40938
Cable: ELECTA JEDDAH
Modern Electronic
Establishment (Branch)
P.O. Box 2726
Tel: 23051/22833
Cable: MATERIO
Genee
190 Blvd. Brahim Roudani
Casablanca
Tel: 15 26 76/25 90 99
Telex: 22 793
Cable: GEREP-CASA
Coppedir
2 Rue d'Agadir, B.P. 156
Casablanca
Tel: 27 65 40
Telex: 21 737
Cable: DODEDIR

SAUDI ARABIA
Modern Electronic
Establishment (Head Office)
P.O. Box 1238, Baghdadah Street
Jeddah
Tel: 27 798
Telex: 40938
Cable: ELECTA JEDDAH
Modern Electronic
Establishment (Branch)
P.O. Box 2726
Tel: 23051/22833
Cable: MATERIO
Genee
190 Blvd. Brahim Roudani
Casablanca
Tel: 15 26 76/25 90 99
Telex: 22 793
Cable: GEREP-CASA
Coppedir
2 Rue d'Agadir, B.P. 156
Casablanca
Tel: 27 65 40
Telex: 21 737
Cable: DODEDIR

SPAIN
Hewlett-Packard Española, S.A.
Av. Ramón y Cajal, 1
Edificio Sevilla, planta 9ª
Sevilla 5
Spain
Tel: 64 44 54/58
Hewlett-Packard Española S.A.
Edificio Albia II 7º B
E-Bilbao
Tel: 23 83 08/23 82 06
Hewlett-Packard Española S.A.
C/Ramón Gorrillio 1
(Valencia)
E-46100 Burjassot
Tel: 96-361 13, 54/361 13, 58

SPAIN
Hewlett-Packard Española, S.A.
Av. Ramón y Cajal, 1
Edificio Sevilla, planta 9ª
Sevilla 5
Spain
Tel: 64 44 54/58
Hewlett-Packard Española S.A.
Edificio Albia II 7º B
E-Bilbao
Tel: 23 83 08/23 82 06
Hewlett-Packard Española S.A.
C/Ramón Gorrillio 1
(Valencia)
E-46100 Burjassot
Tel: 96-361 13, 54/361 13, 58

SPAIN
Hewlett-Packard Española, S.A.
Av. Ramón y Cajal, 1
Edificio Sevilla, planta 9ª
Sevilla 5
Spain
Tel: 64 44 54/58
Hewlett-Packard Española S.A.
Edificio Albia II 7º B
E-Bilbao
Tel: 23 83 08/23 82 06
Hewlett-Packard Española S.A.
C/Ramón Gorrillio 1
(Valencia)
E-46100 Burjassot
Tel: 96-361 13, 54/361 13, 58

SPAIN
Hewlett-Packard Española, S.A.
Av. Ramón y Cajal, 1
Edificio Sevilla, planta 9ª
Sevilla 5
Spain
Tel: 64 44 54/58
Hewlett-Packard Española S.A.
Edificio Albia II 7º B
E-Bilbao
Tel: 23 83 08/23 82 06
Hewlett-Packard Española S.A.
C/Ramón Gorrillio 1
(Valencia)
E-46100 Burjassot
Tel: 96-361 13, 54/361 13, 58

SPAIN
Hewlett-Packard Española, S.A.
Av. Ramón y Cajal, 1
Edificio Sevilla, planta 9ª
Sevilla 5
Spain
Tel: 64 44 54/58
Hewlett-Packard Española S.A.
Edificio Albia II 7º B
E-Bilbao
Tel: 23 83 08/23 82 06
Hewlett-Packard Española S.A.
C/Ramón Gorrillio 1
(Valencia)
E-46100 Burjassot
Tel: 96-361 13, 54/361 13, 58

SPAIN
Hewlett-Packard Española, S.A.
Av. Ramón y Cajal, 1
Edificio Sevilla, planta 9ª
Sevilla 5
Spain
Tel: 64 44 54/58
Hewlett-Packard Española S.A.
Edificio Albia II 7º B
E-Bilbao
Tel: 23 83 08/23 82 06
Hewlett-Packard Española S.A.
C/Ramón Gorrillio 1
(Valencia)
E-46100 Burjassot
Tel: 96-361 13, 54/361 13, 58

SPAIN
Hewlett-Packard Española, S.A.
Av. Ramón y Cajal, 1
Edificio Sevilla, planta 9ª
Sevilla 5
Spain
Tel: 64 44 54/58
Hewlett-Packard Española S.A.
Edificio Albia II 7º B
E-Bilbao
Tel: 23 83 08/23 82 06
Hewlett-Packard Española S.A.
C/Ramón Gorrillio 1
(Valencia)
E-46100 Burjassot
Tel: 96-361 13, 54/361 13, 58

SPAIN
Hewlett-Packard Española, S.A.
Av. Ramón y Cajal, 1
Edificio Sevilla, planta 9ª
Sevilla 5
Spain
Tel: 64 44 54/58
Hewlett-Packard Española S.A.
Edificio Albia II 7º B
E-Bilbao
Tel: 23 83 08/23 82 06
Hewlett-Packard Española S.A.
C/Ramón Gorrillio 1
(Valencia)
E-46100 Burjassot
Tel: 96-361 13, 54/361 13, 58

SPAIN
Hewlett-Packard Española, S.A.
Av. Ramón y Cajal, 1
Edificio Sevilla, planta 9ª
Sevilla 5
Spain
Tel: 64 44 54/58
Hewlett-Packard Española S.A.
Edificio Albia II 7º B
E-Bilbao
Tel: 23 83 08/23 82 06
Hewlett-Packard Española S.A.
C/Ramón Gorrillio 1
(Valencia)
E-46100 Burjassot
Tel: 96-361 13, 54/361 13, 58

SPAIN
Hewlett-Packard Española, S.A.
Av. Ramón y Cajal, 1
Edificio Sevilla, planta 9ª
Sevilla 5
Spain
Tel: 64 44 54/58
Hewlett-Packard Española S.A.
Edificio Albia II 7º B
E-Bilbao
Tel: 23 83 08/23 82 06
Hewlett-Packard Española S.A.
C/Ramón Gorrillio 1
(Valencia)
E-46100 Burjassot
Tel: 96-361 13, 54/361 13, 58

SPAIN
Hewlett-Packard Española, S.A.
Av. Ramón y Cajal, 1
Edificio Sevilla, planta 9ª
Sevilla 5
Spain
Tel: 64 44 54/58
Hewlett-Packard Española S.A.
Edificio Albia II 7º B
E-Bilbao
Tel: 23 83 08/23 82 06
Hewlett-Packard Española S.A.
C/Ramón Gorrillio 1
(Valencia)
E-46100 Burjassot
Tel: 96-361 13, 54/361 13, 58

SPAIN
Hewlett-Packard Española, S.A.
Av. Ramón y Cajal, 1
Edificio Sevilla, planta 9ª
Sevilla 5
Spain
Tel: 64 44 54/58
Hewlett-Packard Española S.A.
Edificio Albia II 7º B
E-Bilbao
Tel: 23 83 08/23 82 06
Hewlett-Packard Española S.A.
C/Ramón Gorrillio 1
(Valencia)
E-46100 Burjassot
Tel: 96-361 13, 54/361 13, 58

SPAIN
Hewlett-Packard Española, S.A.
Av. Ramón y Cajal, 1
Edificio Sevilla, planta 9ª
Sevilla 5
Spain
Tel: 64 44 54/58
Hewlett-Packard Española S.A.
Edificio Albia II 7º B
E-Bilbao
Tel: 23 83 08/23 82 06
Hewlett-Packard Española S.A.
C/Ramón Gorrillio 1
(Valencia)
E-46100 Burjassot
Tel: 96-361 13, 54/361 13, 58

SWEDEN
Hewlett-Packard Sverige AB
Engelsvägen 3, Fack
S-161 Bromma 20
Tel: (08) 730 05 50
Telex: 10271
Cable: MEASUREMENTS
Stockholm
Hewlett-Packard Sverige AB
Fritällgatan 30
S-421 32 Västra Frölunda
Tel: (031) 49 09 50
Telex: 10721 via Bromme office
Hewlett-Packard (Schweiz) AG
Zürcherstrasse 24
P.O. Box 307
CH-9502 Schlieren-Zürich
Tel: (01) 733 4240
Telex: 53993 hpag ch
Cable: HPAAG CH

SWEDEN
Hewlett-Packard Sverige AB
Engelsvägen 3, Fack
S-161 Bromma 20
Tel: (08) 730 05 50
Telex: 10271
Cable: MEASUREMENTS
Stockholm
Hewlett-Packard Sverige AB
Fritällgatan 30
S-421 32 Västra Frölunda
Tel: (031) 49 09 50
Telex: 10721 via Bromme office
Hewlett-Packard (Schweiz) AG
Zürcherstrasse 24
P.O. Box 307
CH-9502 Schlieren-Zürich
Tel: (01) 733 4240
Telex: 53993 hpag ch
Cable: HPAAG CH

SWEDEN
Hewlett-Packard Sverige AB
Engelsvägen 3, Fack
S-161 Bromma 20
Tel: (08) 730 05 50
Telex: 10271
Cable: MEASUREMENTS
Stockholm
Hewlett-Packard Sverige AB
Fritällgatan 30
S-421 32 Västra Frölunda
Tel: (031) 49 09 50
Telex: 10721 via Bromme office
Hewlett-Packard (Schweiz) AG
Zürcherstrasse 24
P.O. Box 307
CH-9502 Schlieren-Zürich
Tel: (01) 733 4240
Telex: 53993 hpag ch
Cable: HPAAG CH

SWEDEN
Hewlett-Packard Sverige AB
Engelsvägen 3, Fack
S-161 Bromma 20
Tel: (08) 730 05 50
Telex: 10271
Cable: MEASUREMENTS
Stockholm
Hewlett-Packard Sverige AB
Fritällgatan 30
S-421 32 Västra Frölunda
Tel: (031) 49 09 50
Telex: 10721 via Bromme office
Hewlett-Packard (Schweiz) AG
Zürcherstrasse 24
P.O. Box 307
CH-9502 Schlieren-Zürich
Tel: (01) 733 4240
Telex: 53993 hpag ch
Cable: HPAAG CH

SWEDEN
Hewlett-Packard Sverige AB
Engelsvägen 3, Fack
S-161 Bromma 20
Tel: (08) 730 05 50
Telex: 10271
Cable: MEASUREMENTS
Stockholm
Hewlett-Packard Sverige AB
Fritällgatan 30
S-421 32 Västra Frölunda
Tel: (031) 49 09 50
Telex: 10721 via Bromme office
Hewlett-Packard (Schweiz) AG
Zürcherstrasse 24
P.O. Box 307
CH-9502 Schlieren-Zürich
Tel: (01) 733 4240
Telex: 53993 hpag ch
Cable: HPAAG CH

SWEDEN
Hewlett-Packard Sverige AB
Engelsvägen 3, Fack
S-161 Bromma 20
Tel: (08) 730 05 50
Telex: 10271
Cable: MEASUREMENTS
Stockholm
Hewlett-Packard Sverige AB
Fritällgatan 30
S-421 32 Västra Frölunda
Tel: (031) 49 09 50
Telex: 10721 via Bromme office
Hewlett-Packard (Schweiz) AG
Zürcherstrasse 24
P.O. Box 307
CH-9502 Schlieren-Zürich
Tel: (01) 733 4240
Telex: 53993 hpag ch
Cable: HPAAG CH

SWEDEN
Hewlett-Packard Sverige AB
Engelsvägen 3, Fack
S-161 Bromma 20
Tel: (08) 730 05 50
Telex: 10271
Cable: MEASUREMENTS
Stockholm
Hewlett-Packard Sverige AB
Fritällgatan 30
S-421 32 Västra Frölunda
Tel: (031) 49 09 50
Telex: 10721 via Bromme office
Hewlett-Packard (Schweiz) AG
Zürcherstrasse 24
P.O. Box 307
CH-9502 Schlieren-Zürich
Tel: (01) 733 4240
Telex: 53993 hpag ch
Cable: HPAAG CH

SWEDEN
Hewlett-Packard Sverige AB
Engelsvägen 3, Fack
S-161 Bromma 20
Tel: (08) 730 05 50
Telex: 10271
Cable: MEASUREMENTS
Stockholm
Hewlett-Packard Sverige AB
Fritällgatan 30
S-421 32 Västra Frölunda
Tel: (031) 49 09 50
Telex: 10721 via Bromme office
Hewlett-Packard (Schweiz) AG
Zürcherstrasse 24
P.O. Box 307
CH-9502 Schlieren-Zürich
Tel: (01) 733 4240
Telex: 53993 hpag ch
Cable: HPAAG CH

SWEDEN
Hewlett-Packard Sverige AB
Engelsvägen 3, Fack
S-1